

## Research Article

# Step Soliton Generalized Solutions of the Shallow Water Equations

**A. C. Alvarez,<sup>1,2</sup> A. Meril,<sup>3</sup> and B. Valiño-Alonso<sup>4</sup>**

<sup>1</sup> Department of Fluid Dynamic, IMPA, Dona Castorina 110, Jardim Botânico, 22460-320 Rio de Janeiro, RJ, Brazil

<sup>2</sup> Oceanology Institute, Environmental Agency, Avenida Primera, 18406, Flores, Playa, 11600 C. Habana, Cuba

<sup>3</sup> Laboratoire AOC, Université des Antilles et de la Guyane, Campus de Fouillole, 97159 Pointe-à-Pitre, Guadeloupe

<sup>4</sup> Departamento de Matemáticas, Facultad de Matemáticas y Computación, Universidad de la Habana, San Lázaro esq. A L, 10400 La Habana, Cuba

Correspondence should be addressed to A. C. Alvarez, meissa98@impa.br

Received 5 January 2012; Revised 11 April 2012; Accepted 19 April 2012

Academic Editor: Armin Troesch

Copyright © 2012 A. C. Alvarez et al. This is an open access article distributed under the Creative Commons Attribution License, which permits unrestricted use, distribution, and reproduction in any medium, provided the original work is properly cited.

Generalized solutions of the shallow water equations are obtained. One studies the particular case of a generalized soliton function passing by a variable bottom. We consider a case of discontinuity in bottom depth. We assume that the surface elevation is given by a step soliton which is defined using generalized solutions (Colombeau 1993). Finally, a system of functional equations is obtained where the amplitudes and celerity of wave are the unknown parameters. Numerical results are presented showing that the generalized solution produces good results having physical sense.

## 1. Introduction

The classical nonlinear shallow water equations were derived in [1]. There exist several works devoted to the applications, validations, or numerical solutions of these equations [2–5]. These equations provide a significant improvement over linear wave theory to describe the wave-breaking process [6].

Shallow water equations have been submitted to numerous improvements to include several physical effects. In such sense, several dispersive extensions were developed. The inclusion of dispersive effects resulted in a big family of the so-called Boussinesq-type equations [7–10]. Many other families of dispersive wave equations have been proposed as

well [11–13]. Other studies attempt to include the effect of different types of bottom shape [4, 14–19]. Also in [20, 21], the mild slope hypothesis is not required, and rapidly varying topographies was also considered. In these studies, the asymptotical expansion method was used. In [22] was included different geometry bathymetric by improving the shallow water equations by using variational principles.

However, there are a few studies which attempt to include the discontinuous or not differentiable bottom effect into shallow water equations [23–25]. One reason is that in its deduction procedure, assume certain restrictions on bottom type function as differentiability. In [3], a numerical method to studding the discontinuous bottom was used.

In this paper, we relaxedly completed this hypothesis allowing that the bottom function must be not differentiable by using the Colombeau algebra [26, 27] studying the shallow water equations with a discontinuous bottom. This algebra comes being used in several applications of the physics fields studying nonlinear partial differential equation. In this theory, the previous solutions are still valid because of the natural embedding of the distribution in the sense of Schwartz in this algebra. In particular the smooth functions are embedded as a constant sequence. However, this theory is specially useful when the product distribution is not allowed or when a formalism of continuous function is not more valid. Details of Colombeau algebra in the applications to hydrodynamics of can be found in [28].

The method presented in this paper is general, and it can be used for a wide class of nonlinear dispersive wave equations such as Boussinesq-like system of equations. In order to try the possibilities of this theory, we consider the equation deduced in [6] with the principles that the equality  $p - p_o = \rho g(h_o + \eta)$  holds; here,  $p$  is the pressure,  $h_o$  is the depth,  $\rho$  is the density of the water, and  $\eta$  is the surface elevation. This equality for the discontinuous bottom case is not more valid in the classical sense. So, we embedded the classical distribution in the generalized function where the nonlinear operations are allowed. Also, we consider the dispersive equations deduced in [8] which is valid to variable smooth bottom. Similar formulas obtained in this paper were obtained in [29] by using the method of the lines.

To study the nonlinear and bottom irregularities effects, we consider the shallow water equations to simulate a generalized soliton passing by discontinuity in the bottom. The idea of taking a soliton to describe a traveling wave and singular solution as a soliton was developed by several works [30–35]. In [36], a generalized solution in the frame of Colombeau's generalized functions was obtained. Solitons are used in coastal engineering to describe waves approximating to the coast with the presence of a vertical structure [37–41]. The evolution of a solitary wave at an abrupt junction was measured and discussed by [42] in detail. There exist a number of physical reasons to suppose that the propagation of a soliton wave over a discontinuity point in the bottom preserves the shape and the structure of an initial wave [43].

The starting point, that the bottom has a discontinuity, constitutes a generalization of submerged structure or coral reef representation. This situation is equivalent, in practical engineering, to the presence of a vertical hard structure that in some cases breaks the wave propagation. As a wave propagates over the structure, part of the wave energy is reflected back to the open ocean, part of the energy is transmitted to the coast, and part of the energy is converted to turbulence and further dissipated in the vicinity of the structures [39, 44]. These processes we approximated by using two generalized solitons traveling in opposite direction.

In this paper, we obtain generalized solutions of the shallow water equations in the one-dimensional case. The approximate solution is obtained as a singular solution. We suppose that in microscopic sense, when a wave crosses the discontinuity bottom point, one part continues its propagation to the shore, preserving the initial structure, while another part

is reflected. We use a generalized soliton function which has macroscopic aspect in sense of Colombeau [27], that is, for a given  $\tau_1$ ,  $S_{\tau_1}(\tau) = 0$  for  $\tau < -\tau_1$ ,  $S_{\tau_1}(\tau) = 1$  for  $-\tau_1 < \tau < \tau_1$  and  $S_{\tau_1}(\tau) = 0$  for  $\tau > \tau_1$ . We obtain a nice procedure that reduces the problem of finding a solution of nonlinear partial differential equation to the one of solving a system of algebraic equations. Since this attempt used this theory to obtain practical formulas, we prove that in the limit, the Step generalized solution agreement reasonably with previous classical solutions. Moreover, we prove that by fixing some parameter that appears in this theory, some nonlinear and dispersive effects are reproduced well.

This paper begins with a description of the Colombeau algebra. Some useful proposition including different product of generalized function was established to simplify some nonlinear operations. After that, generalized solutions are obtained for the flat bottom for two types of shallow water equations. In both cases the generalized solution is compared with previous formulas. Finally, we propose a method to obtain the generalized solution in the discontinuous bottom case. The accuracy of the numerical scheme for solving the shallow water equations was verified by comparing the numerical results with the theoretical solutions obtained by [45] and experimental data obtained in [46].

## 2. Colombeau Algebra

In this paper, we use a generalized solution deduced from the algebra of Colombeau [27, 47]. Such solution permits to construct a singular solution of the system of conservation law that preserves its structures and initial shape. These functions appear in the multiplication of distributions theory when nonlinear differential equations are studied.

The mathematical theory of generalized solutions allows to obtain new formulas and numerical results [48]. The method proposed in [26, 49] is quite general, but each particular problem requires the definition of specific generalized functions. A general definition can be found in the specialized literature (see as an example [26, 27, 47]). Here, we present a version which is sufficient for the purpose of this paper. Let  $\Omega$  be an open subset in  $\mathbb{R}$ . Putting

$$\begin{aligned} E_s(\Omega) &= \{R_1 : (\epsilon, x) \in (0, 1) \times \Omega \longrightarrow \mathbb{R} \text{ such that } R_1 \in C^\infty(\Omega), \forall \epsilon \in (0, 1)\}, \\ E_M(\Omega) &= \left\{ \begin{array}{l} R_1 \in E_s(\Omega) / \forall \text{compact } K \subset \Omega \text{ and for all differential operator} \\ D : \exists q \in \mathbb{N}, c > 0, \eta > 0 \text{ such that } |DR_1(\epsilon, x)| \leq c\epsilon^{-q}, \forall x \in K, \forall 0 < \epsilon < \eta \end{array} \right\}, \\ N(\Omega) &= \left\{ \begin{array}{l} R_1 \in E_M(\Omega) / (\forall K) \subset \Omega \text{ compact and } \forall D \text{ differential operator, } \exists q \in \mathbb{N}, \\ \forall p \geq q, \exists c > 0, \eta > 0, \text{ such that } |DR_1(\epsilon, x)| \leq c\epsilon^{p-q}, \forall x \in K, \forall 0 < \epsilon < \eta \end{array} \right\}, \end{aligned} \quad (2.1)$$

$E_s(\Omega)$  and  $E_M(\Omega)$  are algebras, and  $N(\Omega)$  is an ideal of  $E_s(\Omega)$ .

*Definition 2.1.* The simplified algebra of generalized functions is the quotient space  $\mathfrak{S}_s(\Omega) = E_s(\Omega) / N(\Omega)$ .

The elements  $G$  of  $\mathfrak{S}_s(\Omega)$  are denoted by  $G = R_1(\epsilon, x) + N(\Omega)$ . Distribution of compact support on  $\mathbb{R}$  can be embedded on  $\mathfrak{S}_s(\mathbb{R})$  by convolution with a mollifier  $\rho_\epsilon$ , defined as follows: let  $\rho \in S(\mathbb{R})$  (Schwartz's space) with the properties  $\int \rho(x) dx = 1$ ,  $\int x^\alpha \rho(x) dx = 0$ , for all  $\alpha \in \mathbb{N}^2$ ,  $|\alpha| > 1$ , then we set  $\rho_\epsilon(x) := (1/\epsilon)^2 \rho(x/\epsilon)$ . Then the generalized function  $\int x^\alpha \rho_\epsilon(x - y) w(x) dx + N(\Omega)$  belongs to  $\mathfrak{S}_s(\mathbb{R})$  [28].

$\mathfrak{S}_s(\Omega)$  is clearly an algebra with the usual pointwise operations of addition, inner multiplication, and exterior multiplication by scalars. In this algebra, there are two equalities, one strong (=) and one weak ( $\sim$ ). The strong one is the classical algebraic equality. The weak one is called association and is denoted by the symbol  $\sim$ ; in other words, two simplified generalized functions are equal if the difference of two of their representatives belongs to the ideal  $N(\Omega)$ . Also, whereas multiplication is compatible with equality in  $\mathfrak{S}_s(\Omega)$ , it is not compatible with association. Therefore, the distinction between (=) and ( $\sim$ ) automatically ensures that the physically correct solution is selected, a distinction that can be made in analytical as well as in numerical calculations by using a suitable algorithm [27, 28].

*Definition 2.2.* Two generalized functions  $G_1, G_2 \in \mathfrak{S}_s(\Omega)$  are associated,  $G_1 \sim G_2$ , if there exists representatives  $R_1, R_2 \in E_s(\Omega)$  of  $G_1, G_2$  respectively, such that: for all  $\psi \in D(\mathbb{R})$ ,  $\int_{\mathbb{R}} (R_1(\epsilon, x) - R_2(\epsilon, x))\psi(x)dx \rightarrow 0$  when  $\epsilon \rightarrow 0$ .

In the interpretation of the generalized solution, we use that two different generalized functions associated with the same distribution differ by an infinitesimal.

It is well known from the classical asymptotical method that the several solutions depend on an infinitesimal  $\epsilon$ . For example, in [6, page 470], the solution of the Korteweg de Vries is given in linear limit as  $\zeta_\epsilon = \lambda \cos(\epsilon(x - ct))$ , whereas in the solitary waves limit as  $\zeta_\epsilon = \lambda \operatorname{sech}(\epsilon(x - ct))$ . In [36], similar solutions are obtained in the sense of Colombeau. These functions show that even in the classical sense, the solution is given by a family of functions. The idea to look for a generalized solution in the sense of Colombeau means to seek a solution like a family that depend of one infinitesimal, but this extension must guarantee that they keep valid the association by differentiation and nonlinear operations between them.

The generalized functions have useful properties for our purpose:

- (i)  $C^\infty(\Omega) \subset \mathfrak{S}_s(\Omega)$ ,
- (ii) let  $\rho \in D(\mathbb{R})$  be a  $C^\infty(\mathbb{R})$  function such that  $\int_{\mathbb{R}} \rho(x)dx = 1$ . Then the class of  $R_1(\epsilon, x) = (1/\epsilon)\rho(x/\epsilon)$  is an element of  $\mathfrak{S}_s(\Omega)$  associated with the Dirac delta function, that is, for all  $\psi \in D(\mathbb{R})$ ,  $\int_{\mathbb{R}} R_1(\epsilon, x)\psi(x)dx \rightarrow \psi(0)$ , when  $\epsilon \rightarrow 0$ , where  $D(\mathbb{R})$  denotes the space of the infinitely smooth functions on  $\mathbb{R}$  with compact support.
- (iii) it is possible to define the integral of generalized functions in the following way: let  $G \in \mathfrak{S}_s(\mathbb{R})$  and  $R_1 \in E_s(\mathbb{R})$  a representative. The application  $R_2 : (\epsilon, x) \in (0, 1) \times \mathbb{R} \rightarrow \mathbb{R}$  is defined by

$$(\epsilon, x) \longrightarrow R_2(\epsilon, x) = \int_{x_0}^x R_1(\epsilon, x)dx, \quad (2.2)$$

then  $R_2 \in E_s(\mathbb{R})$ , for all  $x_0 \in \mathbb{R}$ . The class  $J \in \mathfrak{S}_s(\mathbb{R})$  of  $R_2$  verifies  $dJ/dx = J' = G$  and is called a primitive of  $G$ .

The association  $\sim$  is stable by differentiation but not by multiplication, that is, if  $G_1, G_2, G \in \mathfrak{S}_s(\mathbb{R})$ , and  $G_1 \sim G_2$  then  $G'_1 \sim G'_2$ , but  $GG_1$  and  $GG_2$  are not necessarily associated.

*Definition 2.3.* A generalized function  $H \in \mathfrak{S}_s(\mathbb{R})$  is called a Heaviside generalized function if it has representative  $R \in E_s(\mathbb{R})$  such that there exists a sequence of real numbers  $A(\epsilon) > 0$ ,  $A(\epsilon) \rightarrow 0$ , when  $\epsilon \rightarrow 0$  such that

- (i)  $R(\epsilon, x) = 0$ , for all  $\epsilon > 0$ , and  $x < -A(\epsilon)$ ,
- (ii)  $R(\epsilon, x) = 1$ , for all  $\epsilon > 0$ , and  $x > A(\epsilon)$ ,
- (iii)  $\sup |R(\epsilon, x)| < +\infty$ ,  $\epsilon > 0$ , and  $x \in \mathbb{R}$ .

The Heaviside generalized functions are associated between them. Moreover,  $H^n \sim H$  for  $n \in \mathbb{N}$ ,  $n > 0$ .

*Definition 2.4.* A generalized function  $\delta \in \mathfrak{S}_s(\mathbb{R})$  is called Dirac generalized function if it has a representative  $R \in E_s(\mathbb{R})$  such that there exists a sequence  $A(\epsilon) > 0$ ,  $A(\epsilon) \rightarrow 0$ , when  $\epsilon \rightarrow 0$  such that

- (i)  $R(\epsilon, x) = 0$ , for all  $\epsilon > 0$ , and  $|x| > A(\epsilon)$ ,
- (ii)  $\int_{\mathbb{R}} R(\epsilon, x) dx = 1$ , for all  $\epsilon > 0$ ,
- (iii)  $\int_{\mathbb{R}} |R(\epsilon, x)| dx < C$ , for all  $\epsilon > 0$ , where  $C$  is a constant independent of  $\epsilon$ .

It is possible to check that the relation  $H' \sim \delta$  holds between Heaviside and Dirac generalized functions. Moreover, for a reasonable Heaviside and Dirac generalized function, there exists a constant  $M$  such that  $H\delta \sim M\delta$ .

*Definition 2.5.* For a given  $\tau_1 > 0$ , a generalized function  $S_{\tau_1} \in \mathfrak{S}_s(\mathbb{R})$  is called a step soliton generalized function if it has a representative  $R \in E_s(\mathbb{R})$  defined by

$$(i) R(\epsilon, x) = R_1(\epsilon, x - \tau_1) - R_2(\epsilon, x + \tau_1),$$

where  $R_1, R_2 \in E_s(\mathbb{R})$  are representative, of a Heaviside generalized function.

For instance,  $R_1(\epsilon, x) = 0$  if  $x + \tau_1 \leq 0$ ,  $R_1(\epsilon, x) = 1$  if  $x + \tau_1 \geq \epsilon$ , and  $R_1(\epsilon, x) > 0$  if  $0 < x + \tau_1 \leq \epsilon$  (see Figure 1(a)). Besides,  $R_2(\epsilon, x) = 0$  if  $x - \tau_1 \leq 0$ ,  $R_2(\epsilon, x) = 1$  if  $x - \tau_1 \geq \epsilon$ , and  $R_2(\epsilon, x) > 0$  if  $0 < x - \tau_1 \leq \epsilon$  (see Figure 1(b)). In Figure 1(c), the graph of  $R_1(\epsilon, x + \tau_1) - R_1(\epsilon, x - \tau_1)$  is shown.

From Definition 2.5, we obtain that the equality  $S_{\tau_1}(x) = H(x + \tau_1) - H(x - \tau_1)$  holds. Moreover, the macroscopic aspect of the step generalized function is not necessarily symmetric (see Figure 1). A lesson from this application is that by assuming that physically relevant distributions such as Heaviside  $H$  and Dirac  $\delta$  generalized function are elements of  $\mathfrak{S}_s(\mathbb{R})$ ; one gets a picture that is much closer to reality than if they are restricted to classical sense. This fact can be exploited in mathematical and physical modeling. We can verify that the step generalized soliton has one as the maximum value of its representatives. Thus, it is possible to verify that the generalized function  $\lambda S_{\tau_1}$  has  $\lambda$  as the maximum values.

*Definition 2.6.* A generalized function  $\delta_1 \in \mathfrak{S}_s(\mathbb{R})$  is called a microscopic soliton generalized function if it has a representative  $R \in E_s(\mathbb{R})$  defined by

$$(i) R(\epsilon, x) = 1 - R_1(\epsilon, x) - R_1(\epsilon, -x),$$

where  $R_1 \in E_s(\mathbb{R})$  is a representative of a Heaviside generalized function.

From Definition 2.6, we obtain that the relation  $\delta_1(\tau) = (1 - H(\tau) - H(-\tau))$  holds. Moreover,  $\delta_1$  generates a family of generalized functions with different height  $\gamma$ , that is,  $\delta_\gamma(\tau) = \gamma\delta_1(\tau)$ . Let us denote by  $\theta$  the function that satisfies

$$\theta(x) = 0, \quad \text{for } x < 0, \quad \theta(x) = \frac{\pi}{2}, \quad \text{for } x = 0, \quad \theta(x) = 0, \quad \text{for } x > 0. \quad (2.3)$$

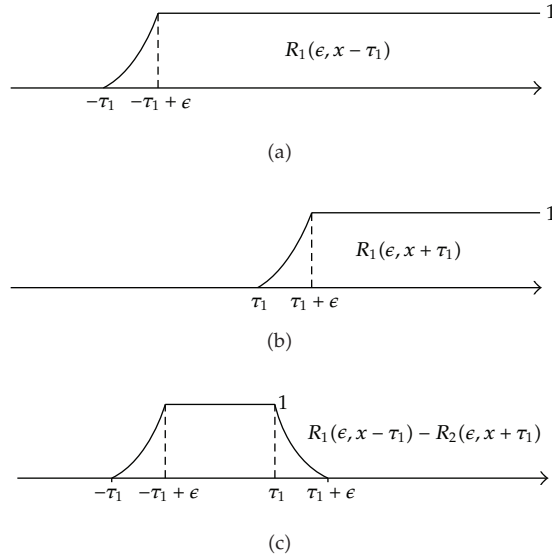

**Figure 1:** Sketch of a representative of step soliton generalized function.

Then the function  $\theta$  has the macroscopic aspect of the generalized function  $\delta_{\pi/2} = (\pi/2)\delta_1$ . Then we have

$$\delta_{\pi/2} = \theta, \quad (2.4)$$

where  $\theta$  is given in (2.3), and  $\delta_{\pi/2}$  is the microscopic soliton with height  $\pi/2$ . Let us define the composite function

$$\cos(\theta(x)) = 0, \quad \text{for } x < 0, \quad \cos(\theta(x)) = \frac{\pi}{2}, \quad \text{for } x = 0, \quad \cos(\theta(x)) = 0, \quad \text{for } x > 0, \quad (2.5)$$

where  $\theta(x)$  is given in (2.3). It is possible to check that the generalized function  $\cos(\theta(x))$  has the macroscopic aspect of the generalized function  $1 - \delta_1$ , where  $\delta_1$  is the microscopic soliton of height one, that is,

$$\cos(\delta_{\pi/2}) = 1 - \delta_1. \quad (2.6)$$

Let us denote

$$\vartheta(x) = \vartheta_1, \quad \text{for } x < 0, \quad \vartheta(x) = \vartheta_2, \quad \text{for } x > 0, \quad (2.7)$$

with real numbers  $\vartheta_1 > \vartheta_2$ . Now, using the Heaviside generalized function  $H$ , we can write

$$\vartheta(x) = \vartheta_1 + (\vartheta_2 - \vartheta_1)H(x). \quad (2.8)$$

We can check that the angle  $\theta$  in respect of axis  $OX$  in each point of the function  $\vartheta(x)$  is given by (2.3). Since  $\tan(\theta(x)) = \vartheta'(x)$ , where  $\vartheta'(x)$  is the derivative of  $\vartheta(x)$ , we have using (2.4) that

$$\tan(\delta_{\pi/2}) = (\vartheta_2 - \vartheta_1)\delta(x), \quad (2.9)$$

where  $\delta$  is the Dirac generalized function.

### 3. Some Useful Lemmas

Reviewing cases of the product of two step generalized functions, the product with function Heaviside generalized function, and the product derivatives of step generalized functions, as well as products with the microscopic generalized functions, it should be noted that the depth with a discontinuity is closer to the combination of the Heaviside generalized functions. In the calculations with generalized function on the shallow water equations arise the derivatives of Heaviside generalized functions which are reasonably approximated by delta generalized function. In short, in the upcoming paragraph, we show those useful lemmas of the product of generalized functions that allow to simplify the calculations and obtain in this way algebraic equations.

To prove the main results of this paper these lemmas of generalized functions are needed. Such lemmas consist in simplifying association between the product of several generalized functions that appears in the algebras of substitution of the proposal solution in the shallow water equations. Let us prove the following.

**Lemma 3.1.** *Given  $\tau_1 > 0$ , let it be denoted by  $S_{\tau_1}$  and  $H$  the step and Heaviside generalized functions respectively. Then the following relations hold:*

$$S'_{\tau_1}(x - ct)H(x) \sim MS'_{\tau_1}(x - ct), \quad (3.1)$$

$$S'_{\tau_1}(x + ct)H(x) \sim 0, \quad (3.2)$$

where  $M, c > 0$  are constants and  $t > 0$ .

*Proof.* We have that  $S'_{\tau_1}(x - ct) = \delta(x - ct + \tau_1) - \delta(x - ct - \tau_1)$ . From this there exists constant  $M$  such that for  $t > 0, c > 0$ , and  $ct - \tau_1 > 0$ , we have  $\delta(x - ct + \tau_1)H(x) \sim M\delta(x - ct + \tau_1)$  and  $\delta(x - ct - \tau_1)H(x) \sim M\delta(x - ct - \tau_1)$ , then (3.1) holds.

It possible to check that for  $t > 0, c > 0$ , and  $-ct + \tau_1 < 0$ , (3.2) holds.  $\square$

**Lemma 3.2.** *Given  $\tau_1 > 0$ , let it be denoted by  $S_{\tau_1}$  the step generalized functions. Then the following relations hold:*

$$S_{\tau_1}(x - ct)\delta(x) \sim 0, \quad (3.3)$$

$$S_{\tau_1}(x + ct)\delta(x) \sim 0, \quad (3.4)$$

for  $t > 0$  and  $c > 0$ .



*Proof.* We have that  $S_{\tau_1}(x - ct) = H(x - ct + \tau_1) - H(x - ct - \tau_1)$ ,  $\delta(x)H(x - ct + \tau_1) \sim 0$ , and  $\delta(x)H(x - ct - \tau_1) \sim 0$  for  $t > 0$  and  $c > 0$ ; thus, (3.3) holds. Analogously, it is possible to verify that (3.4) holds.  $\square$

The following propositions are useful.

**Lemma 3.3.** *Given  $\tau_1 > 0$ ,  $c > 0$ , and  $t$  such that  $t > \tau_1/c$ , let it be denoted by  $S_{\tau_1}$  and  $S'_{\tau_1}$  the step soliton and its derivative generalized functions, respectively. Then the following relations hold:*

- (i)  $S_{\tau_1}^2 \sim S_{\tau_1}$ ,
- (ii)  $S_{\tau_1}(x - ct)S'_{\tau_1}(x + ct) \sim 0$ ,
- (iii)  $S'_{\tau_1}(x - ct)S_{\tau_1}(x + ct) \sim 0$ .

*Proof.* We prove here that (ii) the others are similar. We have that  $S_{\tau_1}(x - ct) = H(x - ct + \tau_1) - H(x - ct - \tau_1)$  and  $S'_{\tau_1}(x + ct) = \delta(x + ct + \tau_1) - \delta(x + ct - \tau_1)$ , where  $\delta$  and  $H$  are the Dirac and Heaviside generalized function. It is possible to check that for  $t > \tau_1/c$ , the delta soliton of the  $S'_{\tau_1}(x - ct)$  stays in the null part of step soliton  $S_{\tau_1}(x - ct)$ , so (ii) holds.  $\square$

**Lemma 3.4.** *Given  $\tau_1 > 0$ ,  $c > 0$ , and  $t$  such that  $t > \tau_1/c$ , let it be denoted by  $S_{\tau_1}$  and  $\delta_1$  the step soliton and microscopic generalized functions, respectively. Then the following relations hold:*

- (i)  $S'_{\tau_1}(x + ct)\delta_1(x) \sim 0$ ,
- (ii)  $S'_{\tau_1}(x - ct)\delta_1(x) \sim 0$ .

## 4. The Flat Bottom Case

### 4.1. Nonlinear Effect

We consider the so-called shallow water equations in one dimension as given in [6]. Here, we put these equations in the sense of associations of Colombeau as follows:

$$h_t + (hu)_x \sim 0, \quad (4.1)$$

$$(u)_t + \frac{1}{2}(u^2)_x + gh_x \sim 0, \quad (4.2)$$

where  $h$  is the height of water,  $u$  is the velocity, and  $g$  is the gravity constant. This model is relevant even to deep water as long as the velocity stays constant on the thickness of the water layer, otherwise this model corresponds to a damped model since the velocity is averaged which can be deduced, as seen easily; by using the Cauchy Schwartz inequality. We split the height of water as  $h = h_o + \eta$ , where  $h_o$  is the bottom depth, and  $\eta$  is the surface elevation relative to the fixed depth  $h_o$  (which is the case in Figure 2 if the angle in respect to the  $OX$  axis is zero, i.e.,  $\theta = 0$ ). As in [24], we take the following.

*Assumption 4.1.* Particles in a vertical plane at any instant always remain in a vertical plane, that is, the streamwise velocity is uniform over the vertical. Each vertical plane always contains the same particles; hence, the integration volume is moving with the fluid.

With the previous assumption, we have chosen a material reference frame to describe the motion of the soliton in the fluid.



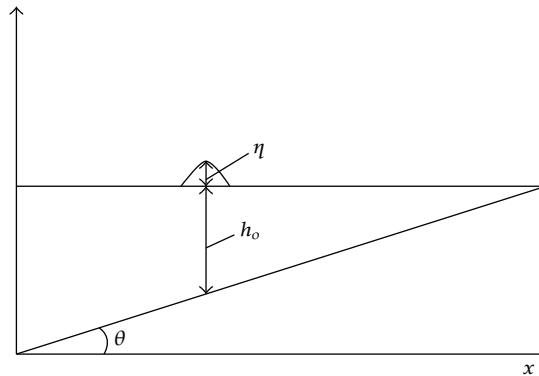

Figure 2: Schematic diagram of a solitary wave propagating over a mild slope bottom.

For a given  $\tau_1$ , let us denote by  $S'_{\tau_1}$  the derivative of the step soliton generalized function  $S_{\tau_1}$ . We interpret (4.1) and (4.2) in the sense of association, that is, we seek the analog of classical weak solutions (see [26, 27, 47, 50]). We are going to seek solutions of the system (4.1) and (4.2) in the form of  $\lambda S_{\tau_1}$  where  $S_{\tau_1}$  is a step soliton generalized function. The following theorem holds.

**Theorem 4.2.** *It is assumed that solitons of the system (4.1) and (4.2) are given by*

$$\eta = \lambda S_{\tau_1}(x - X(t)), \tag{4.3a}$$

$$u = u_o S_{\tau_1}(x - X(t)), \tag{4.3b}$$

for a given  $\tau_1$ , where  $\lambda$  and  $u_o$  are constants representing the amplitude of surface elevation and particle velocity, respectively, and  $h = h_o + \eta$ , where  $h_o$  is a fixed real number. Here,  $X(t)$  is the trajectory where the singularity travels and  $c = X'(t)$  denotes the soliton velocity. Assuming that  $\lambda$  is known, then the wave velocity  $c$  and amplitude of particle velocity  $\alpha$  are given by

$$u_o = \lambda \sqrt{\frac{g}{h_o + \lambda/2}}, \tag{4.4a}$$

$$c = (h_o + \lambda) \sqrt{\frac{g}{h_o + \lambda/2}}. \tag{4.4b}$$

*Proof.* Using that  $h = h_o + \eta$  and substituting (4.3a) and (4.3b) in (4.1) with  $\xi = x - X(t)$ , we obtain

$$\lambda(-X')S'_{\tau_1}(\xi) + u_o \lambda S_{\tau_1}(\xi)S'_{\tau_1}(\xi) + u_o \lambda S_{\tau_1}(\xi)S'_{\tau_1}(\xi) + h_o u_o S'_{\tau_1}(\xi) \sim 0. \tag{4.5}$$

Now, using that  $S_{\tau_1}(\xi)S'_{\tau_1}(\xi) = (1/2)(S_{\tau_1}^2(\xi))'$ , we have

$$\lambda(-X')S'_{\tau_1}(\xi) + u_o \lambda \left( S_{\tau_1}^2(\xi) \right)' + h_o u_o S'_{\tau_1}(\xi) \sim 0. \tag{4.6}$$

Finally, from the fact that  $S_{\tau_1}^2(\xi) \sim S_{\tau_1}(\xi)$ , we deduce that

$$\lambda(-X')S_{\tau_1}'(\xi) + u_o\lambda S_{\tau_1}'(\xi) + h_o u_o S_{\tau_1}'(\xi) \sim 0. \quad (4.7)$$

Since  $S_{\tau_1}'(\xi)$  is not associate to null generalized function, such above equation implies that

$$-X'\lambda + u_o\lambda + h_o u_o = 0, \quad (4.8a)$$

$$X' = \frac{u_o(\lambda + h_o)}{\lambda}. \quad (4.8b)$$

Since that right hand side of (4.8b) is a constant, then the trajectory of the singularity is the straight line rect, that is,

$$X'(t) = \frac{u_o(\lambda + h_o)}{\lambda}t + K, \quad (4.9)$$

where  $K$  is a constant. As a consequence, the soliton velocity is given by

$$c = X'(t) = \frac{u_o(\lambda + h_o)}{\lambda}. \quad (4.10)$$

Now, substituting (4.3a) and (4.3b) in (4.2) and using again the fact that  $S_{\tau_1}S_{\tau_1}' = (1/2)(S_{\tau_1}^2)'$ , we obtain

$$u_o(-X')S_{\tau_1}' + \frac{1}{2}u_o^2(S_{\tau_1}^2)' + g\lambda S_{\tau_1}' \sim 0, \quad (4.11)$$

or equivalently,

$$\left(-X'u_o + \frac{u_o^2}{2} + g\lambda\right)S_{\tau_1}' \sim 0. \quad (4.12)$$

Since  $S_{\tau_1}'$  is not associate to null generalized function, from (4.12), we obtain

$$-X'u_o + \frac{u_o^2}{2} + g\lambda = 0. \quad (4.13)$$

Substituting (4.10) in (4.13), we have

$$-2u_o^2(h_o + \lambda) + 2g\lambda^2 + \lambda u_o^2 = 0. \quad (4.14)$$

From (4.14) we obtain (4.4a), and from (4.4a) and (4.10) we obtain that (4.4b) holds.  $\square$

*Remark 4.3.* The choice of the particle velocity  $u$  as a product by the step generalized function (see (4.3b)) like the free surface stays in concordance with linear wave theory, see as an example [45, 51].

*Remark 4.4.* Taking off the amplitude wave  $\lambda$  from (4.4b) and substituting in (4.4a) we obtain

$$u_o = \frac{u_o h_o}{c - u_o} \sqrt{\frac{g}{h_o + (u_o h_o / (c - u_o))}}. \quad (4.15)$$

Thus, we obtain a close system of equations with (4.4a) and (4.4b), and (4.15), which allows to estimate the wave celerity, velocity particle, and wave amplitude  $(c, u_o, \lambda)$  by using quasi-Newton method, for example.

Theorem 4.2 has an immediate practical sense: the trajectory of the singularity is linear for the case of planar bottom with the system of (4.1) and (4.2).

Let us denote  $\sigma = \lambda/h_o$ ,  $\mu = (hk)^2$ , where  $k$  is number wave, as the nonlinear and dispersive parameters, respectively. From now, we compared the formulas obtained with previous solutions. To do so, we compared the wave celerity of different formulations (see [52]). It is possible to rewrite the wave celerity (4.4b) as follows:

$$c = \sqrt{gh_o} \frac{1 + \lambda/h_o}{1 + \lambda/2h_o} \sqrt{\frac{1}{1 + \lambda/2h_o}}. \quad (4.16)$$

Equation (4.16) for small nonlinear parameter  $\sigma \ll 1$  holds,

$$c = \sqrt{gh_o} \left( 1 + \frac{3}{4} \frac{\lambda}{h_o} - \frac{5}{32} \left( \frac{\lambda}{h_o} \right)^2 + \frac{7}{128} \left( \frac{\lambda}{h_o} \right)^3 + O \left( \frac{\lambda}{h_o} \right)^4 \right). \quad (4.17)$$

Formula (4.17) is similar to those obtained in [6, 53–55] which depends on the nonlinear parameter  $\sigma$ . It is possible to check that the difference of the formula (4.4b) in respect of those obtained in the above-cited review has order  $\sigma$ . In particular, we consider the wave celerity obtained in [6, page 463], that is,  $c_1 = (3\sqrt{g(h_o + \lambda)} - 2\sqrt{gh_o}) = \sqrt{gh_o}(3(1 + \lambda/h_o)^{1/2} - 2)$ , which for small  $\sigma$  holds as follow,

$$c_1 = \sqrt{gh_o} \left( 1 + \frac{3}{2} \frac{\lambda}{h_o} - \frac{3}{8} \left( \frac{\lambda}{h_o} \right)^2 + \frac{3}{16} \left( \frac{\lambda}{h_o} \right)^3 + O \left( \frac{\lambda}{h_o} \right)^4 \right). \quad (4.18)$$

It is possible to verify that the quotient between (4.17) and (4.18) is approximately  $|c|/|c_1| \approx 1 - (3/4)\sigma + (43/32)\sigma^2 + (311/128)\sigma^3$ . Thus, we obtain good matches (maximum difference of less than 10 percent) for  $\sigma < 0.4$  (see Figure 3(a)).

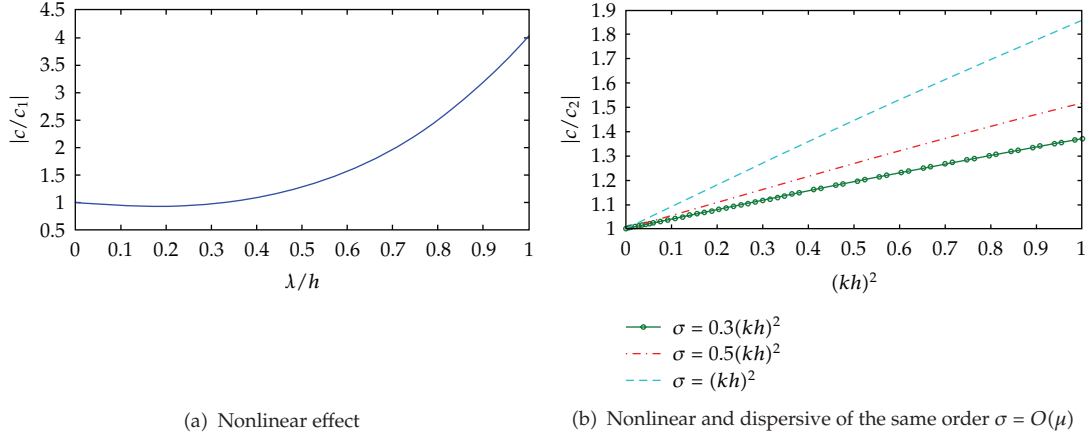

**Figure 3:** Quotient of wave celerity for two formulations. In the case (a), only nonlinear effect was simulated. In the case (b), the dispersive and nonlinear have the same order  $\sigma = O(\mu)$ .

Also, when  $\sigma = O(\mu)$ , the formula for the wave celerity (4.17) is similar to those obtained in [8, 25, 56, 57]. In particular, the quotient in respect to the classical dispersion linear (Airy's wave celerity):

$$c_2 = \sqrt{gh_o} \sqrt{\frac{\tanh(kh)}{kh}} = \sqrt{gh_o} \left( 1 - \frac{1}{6}(kh)^2 + \frac{19}{360}(kh)^4 - \frac{55}{3024}(kh)^6 + O((kh)^8) \right) \quad (4.19)$$

is approximately  $|c|/|c_1| \approx 1 + (11/12)\mu - (9/160)\mu^2 - (53/17280)\mu^3$ . Thus, we obtain maximum difference of less than 10 percent for  $\mu < 0.1$  (see Figure 3(b)). This small range of good matches is expected because in the deduction of (4.4a) and (4.4b), we do not consider the dispersive effect in shallow water equations.

## 4.2. Nonlinear and Dispersive Effects

We consider the following so-called shallow water equations with dispersive effect in one dimension as given in [8]:

$$\begin{aligned} \eta_t + hu_x + (\eta u)_x + \left( \alpha + \frac{1}{3} \right) h^3 u_{xxx} &= 0, \\ (u)_t + g\eta_x + \frac{1}{2}(u^2)_x + \alpha h^2 u_{txx} &= 0, \end{aligned} \quad (4.20)$$

where  $h$  is the height of water,  $u$  is the velocity,  $g$  is the gravity constant, and  $\alpha = (1/2)(z_\alpha/h)^2 + (z_\alpha/h)$  at reference depth  $z_\alpha$ . We assume here that the bottom is constant, that is,  $h = h_o$ . But with the method presented in this paper, it is possible to obtain generalized solutions regarding variable bottom.

The following theorem holds.

**Theorem 4.5.** *It is assumed that solitons of the system (4.20) are given by*

$$\eta = \lambda S_{\tau_1}(kx - \omega t), \quad u = u_o S_{\tau_1}(kx - \omega t), \quad (4.21)$$

for a given  $\tau_1$ , where  $\lambda$  and  $u_o$  are constants representing the amplitude of surface elevation and particle velocity, respectively, and  $h = h_o + \eta$ , where  $h_o$  is a fixed real number. Here,  $k, \omega$  are the wave number and frequency, respectively. Then the following equalities hold:

$$u_o = \lambda \frac{\sqrt{gh_o}}{h_o} \frac{1}{\sqrt{(1 + \sigma/2) + (v_2/2)\alpha\mu((1 + \sigma) + v_1(\alpha + (1/3)\mu k))}}, \quad (4.22)$$

$$\omega = \frac{u_o k}{\lambda} \left( \lambda + h_o + v_1 \left( \alpha + \frac{1}{3} \right) \mu h_o \right), \quad (4.23)$$

where  $v_1, v_2$  are arbitrary constants and  $\sigma$  and  $\mu$  are the nonlinear and dispersive parameters, respectively.

*Proof.* Since the proof is similar to Theorem 4.2, we present a summary here. The idea of the proof consists in substituting the generalized function (4.21) in the system (4.20). By using the relations  $S_{\tau_1}^2(\xi) \sim S_{\tau_1}(\xi)$  and  $S_{\tau_1}(\xi)S_{\tau_1}'(\xi) = (1/2)(S_{\tau_1}^2(\xi))'$ ,  $\xi = kx - \omega t$  and after several operations, we obtain

$$\begin{aligned} (-\omega\lambda + u_o k(h_o + \lambda))S_{\tau_1}'(\xi) + \left( \alpha + \frac{1}{3} \right) k^3 h_o^3 u_o S_{\tau_1}'''(\xi) &\sim 0, \\ \left( -u_o\omega + \frac{1}{2}u_o^2 k + g\lambda k \right) S_{\tau_1}(\xi) - \alpha k^2 h_o^2 u_o \omega S_{\tau_1}'''(\xi) &\sim 0. \end{aligned} \quad (4.24)$$

Finally, taking a representant  $R(\epsilon, \xi) = a_1 + a_2\epsilon\xi + a_3\epsilon^2\xi^2 + a_4\epsilon^3\xi^3 + O(\epsilon^4\xi^4)$  of  $S_{\tau_1}$  and using the Definition 2.2, we obtain that there exist constants  $v_1, v_2$  such that

$$\omega = \frac{u_o k(h_o + \lambda)}{\lambda} + \frac{v_1(\alpha + (1/3))k^3 u_o h_o^3}{\lambda}, \quad (4.25)$$

$$-u_o\omega + \frac{1}{2}u_o^2 k + g\lambda k - v_2\alpha k^2 h_o^2 \omega u_o = 0. \quad (4.26)$$

Combining (4.25) and (4.26), we obtain (4.22) and (4.23).  $\square$

*Remark 4.6.* Taking  $v_1 = v_2 = 0$  in (4.25) and (4.26), that is, neglecting the dispersive effects, it is possible to verify that (4.22) and (4.23) are the same as that (4.4a) and (4.4b) in Theorem 4.2 (the nonlinear effect alone), which indicates that the calculations are consistent.

From (4.23), we can deduce the wave celerity as

$$c = \sqrt{gh_o} \frac{(1 + \sigma + v_1(\alpha + (1/3))\mu)}{\sqrt{(1 + \sigma/2) + (1/2)v_2\alpha\mu((1 + \sigma) + v_1(\alpha + (1/3))\mu\sqrt{\mu})}}. \quad (4.27)$$

The expression (4.27) is similar to those obtained in [29]. In the following, we verify the similitude of formula (4.27) with Airy's wave celerity. In the simulation we assume that  $\sigma = O(\mu)$  and  $h_o = 1$ . Also we take the value of parameter  $\alpha = -0.39$  from [8]. In Figures 4(a) and 4(b), we present the quotient of the wave celerity (4.27) with Airy's wave celerity, depending on the dispersive parameter  $\mu$  from shallow water ( $0 < \mu < \pi/10$ ) to transitional ( $\pi/10 < \mu < \pi$ ). An optimum value of the parameter  $(\nu_1, \nu_2) = (4.17, -1.7)$  for the range,  $0 < \mu < 2.5$  with  $\sigma = \mu$ , by minimizing the sum of the relative difference between the two wave celerity studies was obtained here. We can see that several pairs of optimum parameters  $(\nu_1, \nu_2)$  produce good matches with greater interval which is better than the nonlinear case (see Figures 4(a) and 4(b)).

## 5. A Discontinuity Bottom Case

In this section, we studied the case in which a soliton crosses a bottom discontinuity (see Figure 5). Seeking the solution of shallow water equation requires some useful lemmas that were proved in Section 3. These propositions contain the key results of the product of generalized functions that appear in the algebraic operations when generalized solution is searched.

### 5.1. Generalized Solution

Following the same idea as in the previous section, we obtain a generalized solution of shallow water equation stated in [6] as in this case one takes into account friction and slope of the bottom

$$h_t + (hu)_x = 0, \quad (5.1)$$

$$(u)_t + \frac{1}{2}(u^2)_x + g'h_x = g'S - C_f u^2, \quad (5.2)$$

where  $g' = g \cos(\theta)$ ,  $S = \tan(\theta)$  with bottom slope  $\theta$  (see Figure 2). Here,  $C_f$  denotes the friction coefficient. Neglecting friction, (5.2) in generalized sense of association is given by

$$h_t + (hu)_x \sim 0, \quad (5.3)$$

$$(u)_t + \frac{1}{2}(u^2)_x + g'h_x \sim g'S. \quad (5.4)$$

Now, we assume that the depth has a jump in the bottom (see Figure 5). In this case, the bottom can be written as

$$h_o(x) = h_1 + (h_2 - h_1)H(x), \quad (5.5)$$

where  $H$  is the Heaviside generalized function, and  $\Delta h = h_2 - h_1$  and  $h_1, h_2$  are constants.

#### 5.1.1. A Case of Single Soliton

Given  $\tau_1 > 0$ , we find a generalized solution of system (5.3) and (5.4) as

$$\eta(x, t) = \lambda S_{\tau_1}(x - X(t)), \quad u(x, t) = \alpha S_{\tau_1}(x - X(t)), \quad (5.6)$$

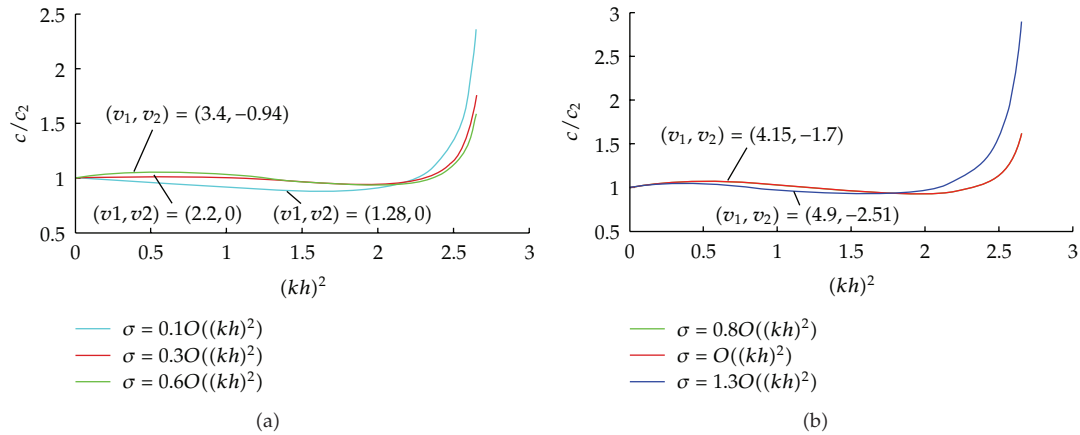

Figure 4: Comparison of wave celerity for dispersive and nonlinear of the same order  $\sigma = O(\mu)$ .

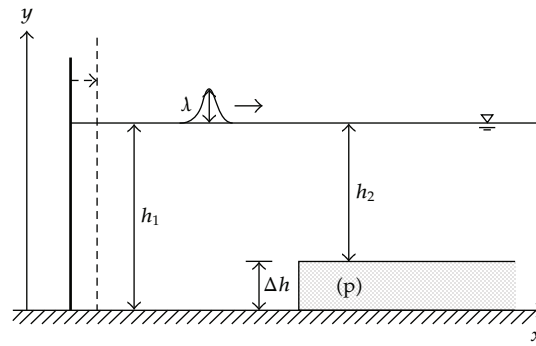

Figure 5: Schematic diagram of a solitary wave propagating over a discontinuity bottom.

where  $X(t)$  is that trajectory of the singularities, and  $S_{\tau_1}$  is the step generalized function. We assume that at time  $t = 0$ , the generalized solution is known, that is,

$$\eta(x, 0) = \lambda S_{\tau_1}(x), \quad u(x, 0) = u_o S_{\tau_1}(x), \tag{5.7}$$

where  $\lambda$  and  $u_o$  are known constants. The following theorem holds.

**Theorem 5.1.** *It is assumed that solitons of the system (5.3) and (5.4) are given by*

$$\eta = \lambda S_{\tau_1}(x - X(t)), \quad u = u_o S_{\tau_1}(x - X(t)), \tag{5.8}$$

for a given  $\tau_1$ , where  $\lambda$  and  $u_o$  are constants representing the amplitude of surface elevation and particle velocity, respectively, and  $h = h_o + \eta$ , where  $h_o$  is given in (5.5). Here,  $X(t)$  is the trajectory where the



singularity travels and let it be denoted by  $c_1 = X'(t)$  for  $x < 0$  and  $c_2 = X'(t)$  for  $x > 0$  the soliton velocity. Assuming that  $\lambda$  is known, then the soliton velocities  $c_1, c_2$  are given by

$$c_1 = u_o \frac{(h_1 + \lambda)}{\lambda}, \quad c_2 = u_o \frac{(h_2 + \lambda)}{\lambda}. \quad (5.9)$$

*Proof.* Substituting (5.6) and (5.5) in (5.3) with  $\xi = x - X(t)$ , we obtain

$$-X'\lambda S'_{\tau_1}(\xi) + (u_o S_{\tau_1}(\xi))(\Delta h \delta(x) + \lambda S'_{\tau_1}(\xi)) + (h_1 + \Delta h H(x) + \lambda S_{\tau_1}(\xi))u_o S'_{\tau_1}(\xi) \sim 0. \quad (5.10)$$

Using that  $S'_{\tau_1}(\xi)S_{\tau_1}(\xi) \sim (1/2)(S_{\tau_1}^2(\xi))'$ , Lemma 3.2 and Lemma 3.3(i), that we have from (5.10)

$$\left(-X'\lambda + \frac{1}{2}u_o\lambda + u_o h_1 + \frac{1}{2}u_o\lambda + u_o \Delta h H(x)\right)S'_{\tau_1}(\xi) \sim 0. \quad (5.11)$$

Since  $S'_{\tau_1}(\xi)$  is not associate to null generalized function, we obtain

$$-X'\lambda + \frac{1}{2}u_o\lambda + u_o h_1 + \frac{1}{2}u_o\lambda + u_o \Delta h H(x) = 0. \quad (5.12)$$

From (5.12), we obtain (5.9). □

*Remark 5.2.* Theorem 5.1 indicates that the trajectory of the singularity of one soliton that passes by the discontinuity point in the bottom consist in a cone. Moreover, the velocity of the soliton is constant and different in both sides of the jump. This suggests from the physical point of view that happened, a rectification of the soliton and velocity only depends on the depth.

### 5.1.2. A Case of Two Solitons

Now, we obtain a solution of shallow water equation as two solitons which we assume are the propagate soliton, and reflected by the jump. Using the heuristic considerations despite in Remark 5.2, we assume that the velocity of the solitons is constant.

Given  $\tau_1 > 0$ , we find a generalized solution of system (5.3) and (5.4) as

$$\begin{aligned} \eta(x, t) &= \lambda_1 S_{\tau_1}(x - c_1 t) + \lambda_2 S_{\tau_1}(x + c_2 t), \\ u(x, t) &= u_{o1} S_{\tau_1}(x - c_1 t) + u_{o2} S_{\tau_1}(x + c_2 t), \end{aligned} \quad (5.13)$$

where  $c_1, c_2$  are constants, and  $S_{\tau_1}$  is the step generalized function. We assume that at time  $t = 0$ , the generalized solution is known, that is,

$$\begin{aligned} \eta(x, 0) &= (\lambda_1 + \lambda_2)S_{\tau_1}(x) = \lambda S_{\tau_1}(x), \\ u(x, 0) &= (u_{o1} + u_{o2})S_{\tau_1}(x) = u_o S_{\tau_1}(x), \end{aligned} \quad (5.14)$$

where  $\lambda = \lambda_1 + \lambda_2$  and  $u_o = u_{o1} + u_{o2}$  are considered as constants. In this case, we consider the discontinuous bottom as in (5.5). The following theorem holds.

**Theorem 5.3.** For given  $\tau_1 > 0$ , let it be assumed that a generalized solution of (5.3) and (5.4) is given by (5.13) with bottom depth given in (5.5). Assuming that the amplitudes  $\lambda$  and  $u_o$  are known, then the wave velocities  $c_1$  and  $c_2$ , the amplitude of particle velocity  $u_{o2}$ , and the amplitude  $\lambda_2$  of reflected wave satisfy on  $t > \min\{\tau_1/c_1, \tau_1/c_2\}$  the following algebraic equations:

$$-c_1(\lambda - \lambda_2) + (u_o - u_{o2})[(\lambda - \lambda_2) + h_1 + M\Delta h] = 0, \quad (5.15)$$

$$\lambda_2 c_2 + u_{o2}[\lambda_2 + h_1] = 0, \quad (5.16)$$

$$-c_1(\lambda - \lambda_2) + \frac{1}{2}(u_o - u_{o2})^2 + g(\lambda - \lambda_2) = 0, \quad (5.17)$$

$$\lambda_2 c_2 + \frac{1}{2}u_{o2}^2 + g\lambda_2 = 0, \quad (5.18)$$

where  $M$  is a constant.

*Proof.* Denote that by  $\xi_1 = x - c_1 t$  and  $\xi_2 = x + c_2 t$ , we have

$$\begin{aligned} \eta(x, t) &= (\lambda - \lambda_2)S_{\tau_1}(\xi_1) + \lambda_2 S_{\tau_1}(\xi_2), \\ u(x, t) &= (u_o - u_{o2})S_{\tau_1}(\xi_1) + u_{o2}S_{\tau_1}(\xi_2), \\ h(x, t) &= h_o(x) + \eta(x, t). \end{aligned} \quad (5.19)$$

Now, substituting (5.19) in (5.3) we obtain

$$\begin{aligned} (h_o(x))_t + (-c_1)(\lambda - \lambda_2)S'_{\tau_1}(\xi_1) + c_2\lambda_2 S'_{\tau_1}(\xi_2) + [(u_o - u_{o2})S_{\tau_1}(\xi_1) + u_{o2}S_{\tau_1}(\xi_2)][h_1 + \Delta hH(x)]_x \\ + [(u_o - u_{o2})S_{\tau_1}(\xi_1) + u_{o2}S_{\tau_1}(\xi_2)][(\lambda - \lambda_2)S'_{\tau_1}(\xi_1) + \lambda_2 S'_{\tau_1}(\xi_2)] \\ + h(x, t)[(u_o - u_{o2})S'_{\tau_1}(\xi_1) + u_{o2}S'_{\tau_1}(\xi_2)] \sim 0. \end{aligned} \quad (5.20)$$

Now, using that  $S_{\tau_1}S'_{\tau_1} = (1/2)(S_{\tau_1}^2)'$  and from Lemma 3.3 that  $S'_{\tau_1}(\xi_1)S_{\tau_1}(\xi_2) \sim 0$ ,  $S'_{\tau_1}(\xi_2)S_{\tau_1}(\xi_1) \sim 0$ , we have

$$\begin{aligned} -c_1(\lambda - \lambda_2)S'_{\tau_1}(\xi_1) + c_2\lambda_2 S'_{\tau_1}(\xi_2) + \Delta h[(u_o - u_{o2})S_{\tau_1}(\xi_1)S(x) + u_{o2}S_{\tau_1}(\xi_2)S(x)] \\ + \left[ \frac{1}{2}(u_o - u_{o2})(\lambda - \lambda_2)(S_{\tau_1}^2(\xi_1))' + \frac{1}{2}\lambda_2 u_{o2}(S_{\tau_1}^2(\xi_2))' \right] + h_1[(u_o - u_{o2})S'_{\tau_1}(\xi_1) + u_{o2}S'_{\tau_1}(\xi_2)] \\ + \Delta h[(u_o - u_{o2})S'_{\tau_1}(\xi_1)H(x) + u_{o2}S'_{\tau_1}(\xi_2)H(x)] \\ + \left[ \frac{1}{2}(\lambda - \lambda_2)(u_o - u_{o2})(S_{\tau_1}^2(\xi_1))' + \lambda_2 u_{o2}(S_{\tau_1}^2(\xi_2))' \right] \sim 0. \end{aligned} \quad (5.21)$$

From Lemma 3.1, we have  $S'_{\tau_1}(\xi_1)H(x) \sim MS'_{\tau_1}(\xi_1)$  and  $S'_{\tau_1}(\xi_2)H(x) \sim 0$  for some constant  $M$  and for  $t, c > 0$ . Also, from Lemma 3.2 we have  $S_{\tau_1}(\xi_1)\delta(x) \sim 0$  and  $S_{\tau_1}(\xi_2)\delta(x) \sim 0$  for  $c_1, c_2, t > 0$ , and since  $S_{\tau_1}^2 \sim S_{\tau_1}$  (see Lemma 3.3(i)), we obtain

$$\begin{aligned} & \left[ -c_1(\lambda - \lambda_2) + \frac{1}{2}(u_o - u_{o2})(\lambda - \lambda_2) + h_1(u_o - u_{o2}) + M\Delta h(u_o - u_{o2}) \right. \\ & \left. + \frac{1}{2}(\lambda - \lambda_2)(u_o - u_{o2}) \right] S'_{\tau_1}(\xi_1) + \left[ \lambda_2 c_2 + \frac{1}{2}u_{o2}\lambda_2 + h_1 u_{o2} + \frac{1}{2}\lambda_2 u_{o2} \right] S'_{\tau_1}(\xi_2) \sim 0. \end{aligned} \quad (5.22)$$

Analogously, substituting (5.19) in (5.4), we obtain

$$\begin{aligned} & -c_1(\lambda - \lambda_2)S'_{\tau_1}(\xi_1) + c_2 u_{o2} S'_{\tau_1}(\xi_2) \\ & + ((u_o - u_{o2})S_{\tau_1}(\xi_1) + u_{o2}S_{\tau_1}(\xi_2))((u_o - u_{o2})S'_{\tau_1}(\xi_1) + u_{o2}S'_{\tau_1}(\xi_2)) \\ & + g'[h_1 + \Delta hH(x)]_x + g'[(\lambda - \lambda_2)S'_{\tau_1}(\xi_1) + \lambda_2 S'_{\tau_1}(\xi_2)] \sim g' \tan(\theta). \end{aligned} \quad (5.23)$$

Now, from Lemma 3.3 (i), we have  $S_{\tau_1}^2 \sim S_{\tau_1}$ . Also from Lemma 3.3(ii)(iii), we have  $S'_{\tau_1}(\xi_1)S_{\tau_1}(\xi_2) \sim 0$  and  $S_{\tau_1}(\xi_1)S'_{\tau_1}(\xi_2) \sim 0$  for  $t > \min\{\tau_1/c_1, \tau_1/c_2\}$ . Since  $S_{\tau_1}S'_{\tau_1} = (1/2)(S_{\tau_1}^2)'$ ,  $S_{\tau_1}(\xi_1)\delta_1 \sim 0$ ,  $S_{\tau_1}(\xi_2)\delta_1 \sim 0$  (Lemma 3.4(i)(ii)), we obtain

$$\begin{aligned} & g'\Delta hH' + \left[ -c_1(\lambda - \lambda_2) + \frac{1}{2}(u_o - u_{o2})^2 + g \cos(\theta)(\lambda - \lambda_2) \right] S'_{\tau_1}(\xi_1) \\ & + \left[ u_{o2}c_1 + \frac{1}{2}u_{o2}^2 + g \cos(\theta)\lambda_2 \right] S'_{\tau_1}(\xi_2) \sim g' \tan(\theta). \end{aligned} \quad (5.24)$$

Finally, using that  $\cos(\theta) \sim 1 - \delta_1(x)$  and  $\tan(\theta) \sim \Delta h\delta$ , where  $\theta$  is the angle in respect to axis  $OX$  (see (2.6) and (2.9)) and using Lemma 3.4, we have

$$\begin{aligned} & g'\Delta h\delta + \left[ -c_1(\lambda - \lambda_2) + \frac{1}{2}(u_o - u_{o2})^2 + g(\lambda - \lambda_2) \right] S'_{\tau_1}(\xi_1) \\ & + \left[ u_{o2}c_1 + \frac{1}{2}u_{o2}^2 + g\lambda_2 \right] S'_{\tau_1}(\xi_2) \sim g'\Delta h\delta, \end{aligned} \quad (5.25)$$

or equivalently,

$$\left[ -c_1(\lambda - \lambda_2) + \frac{1}{2}(u_o - u_{o2})^2 + g(u_o - u_{o2}) \right] S'_{\tau_1}(\xi_1) + \left[ u_{o2}c_1 + \frac{1}{2}u_{o2}^2 + g\lambda_2 \right] S'_{\tau_1}(\xi_2) \sim 0. \quad (5.26)$$

Because that the generalized function of the left hand of (5.22) and (5.26) is equivalent to zero, it is necessary that the coefficient of  $S'_{\tau_1}(\xi_1)$  and  $S'_{\tau_1}(\xi_2)$  must be zero. So, the system of (5.15)–(5.18) holds.  $\square$

*Remark 5.4.* Although Theorem 5.3 was obtained for a discontinuity in the bottom, it is not difficult to generalize this result for any type of bottom. To do so, any geometric of the bottom can be approximated by step functions, and then theorem can be used locally.

*Remark 5.5.* In Theorem 5.3, we assume that  $t > \min\{\tau_1/c_1, \tau_1/c_2\}$ . If we relax this hypothesis, that is, to obtain the generalized solution on  $0 < t < \min\{\tau_1/c_1, \tau_1/c_2\}$ , we have that, following relations hold:

$$S'_{\tau_1}(\xi_1)S_{\tau_1}(\xi_2) \sim \delta(x - ct - \tau_1), \quad S_{\tau_1}(\xi_1)S'_{\tau_1}(\xi_2) \sim -\delta(x + ct + \tau_1), \quad (5.27)$$

where  $\delta$  is the Dirac generalized function. The product of generalized functions (5.27) was taken as null in the proof of Theorem 5.3. In the contrary case, it is possible to check that in the proof (similar to Theorem 5.3), a new equation arises due to the coefficients of  $S'_{\tau_1}(\xi_1)S_{\tau_1}(\xi_2)$  and  $S_{\tau_1}(\xi_1)S'_{\tau_1}(\xi_2)$ , which is

$$(u_o - u_{o2})u_{o2} = 0. \quad (5.28)$$

Equation (5.28) has two solutions which are  $u_o = u_{o2}$  or  $u_{o2} = 0$ . More physical sense has the solution  $u_{o2} = 0$ , which means that for  $t < \min\{\tau_1/c_1, \tau_1/c_2\}$ , the reflected effect of wave velocity particles is not starting yet. In this point, a rise of the wave amplitude near the leading edge of the discontinuous point occurs due to the shallow effect [51]. In that case it is possible to verify that system (5.15)–(5.18) reduces to the system of equations

$$\begin{aligned} -c_1\lambda + u_o(\lambda + h_1 + M\Delta h) &= 0, \\ -c_1\lambda + g\lambda + \frac{1}{2}u_o^2 &= 0. \end{aligned} \quad (5.29)$$

Equation (5.29) for known  $\lambda$  has the explicit solutions:

$$u_o^{1,2} = (h_1 + \lambda + M\Delta h) \pm \sqrt{(h_1 + \lambda + M\Delta h)^2 - 2g\lambda}, \quad c_1^{1,2} = -u_o^{1,2} \frac{h_1 + \lambda + M\Delta h}{\lambda}, \quad (5.30)$$

with  $c_2 = \lambda_2 = u_{o2} = 0$ . However, taking off the amplitude wave  $\lambda$  of (5.29) and equaling it, we obtain

$$\frac{u_o/2}{(g - c_1)} = \frac{h_1 + M\Delta h}{(c_1 - u_o)}. \quad (5.31)$$

Now, solving a close system (5.29), and (5.31), we obtain  $(c_1, u_o, \lambda)$ , that is, wave celerity, particle velocity, and wave amplitude, respectively.

## 6. Numerical Calculation of the Generalized Solution

In this section, we show a numerical procedure to find the unknown parameters  $\lambda_2$  and  $u_{o2}$  which are solution of the system of (5.15)–(5.18). In practical terms to determine those parameters means to calculate the amplitude of the step Soliton when it passes through a point of discontinuity in the bottom. The method consists in reducing the set of four equations to two by eliminating the unknowns  $c_1$  and  $c_2$ . The following lemma holds.

**Lemma 6.1.** *Let it be assumed that a generalized solutions of (5.3) and (5.4) is given by (5.13) with bottom depth given in (5.5). Assuming that  $\lambda$  and  $u_o$  are known, then the amplitude of particle velocity  $u_{o2}$  and the amplitude  $\lambda_2$  of the reflected wave satisfy*

$$\frac{1}{2}u_{o2}^2 - \lambda_2 u_{o2} + g\lambda_2 - u_{o2}h_1 = 0, \quad (6.1)$$

$$\frac{1}{2}(u_o - u_{o2})^2 - (\lambda - \lambda_2)(u_o - u_{o2}) + g(\lambda - \lambda_2) - (u_o - u_{o2})(h_1 + M\Delta h) = 0, \quad (6.2)$$

where  $M$  is a constant.

*Proof.* Equation (6.1) follows from (5.18) minus (5.16). Equation (6.2) follows from (5.17) minus (5.15).  $\square$

Let us denote

$$G_1(u_{o2}, \lambda_2) = \frac{1}{2}u_{o2}^2 - \lambda_2 u_{o2} + g\lambda_2 - u_{o2}h_1, \quad (6.3)$$

$$G_2(u_{o2}, \lambda_2) = \frac{1}{2}(u_o - u_{o2})^2 - (\lambda - \lambda_2)(u_o - u_{o2}) + g(\lambda - \lambda_2) - (u_o - u_{o2})(h_1 + M\Delta h).$$

Now, to find the zeros of (6.1) and (6.2) is equivalent to find the zeros of the application

$$G : (u_{o2}, \lambda_2) \longrightarrow (G_1(u_{o2}, \lambda_2), G_2(u_{o2}, \lambda_2)), \quad (6.4)$$

in the region  $B = \{(u_{o2}, \lambda_2) : 0 < u_{o2} < u_o \text{ and } 0 < \lambda_2 < \lambda\}$ . To do so, it is possible to use the quasi-Newton method.

*Remark 6.2.* Taking  $u_{o2} = 0$ ,  $\lambda_2 = 0$ , and  $\Delta h = 0$ , that is, the flat bottom case, then it is possible to verify that (6.1) and (6.2) is the same as the flat bottom case (4.4a) and (4.4b), which indicates that the calculation in the discontinuous bottom case is consistent.

## 7. Numerical Examples

In this section, we show that the generalized solutions with physical sense can be obtained. To do so, the constant  $M$  in the system of (5.15)–(5.18) can be adjusted such that generalized solutions represent appropriately the theoretical and experimental data.

The initial values of quasi-Newton method for solving (6.1)–(6.2) are taken by using the formula for planar bottom case; that is, assuming the wave celerity is known from (4.4a) and (4.4b), we obtain  $g\lambda^2 + (2gh_o - (c^2/2))\lambda + (gh_o^2 - h_o c^2) = 0$ . It is possible to check that the positive root of the above equation produces a wave amplitude with reasonable value.

In [45, 58] was used the theoretical amplitude of soliton  $\lambda_1$  in the impermeable case with a discontinuity bottom which was deduced in [45], which is

$$\lambda_1^{-1/4} = \lambda^{-1/4} + 0.08356\sqrt{\frac{v}{g^{1/2}h_2^2}}\left(\frac{x}{h_2}\right), \quad (7.1)$$

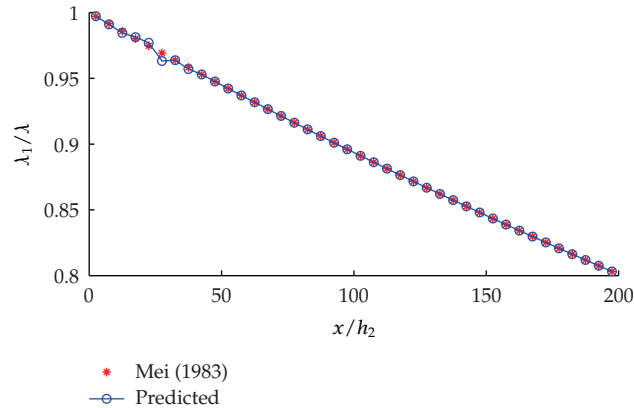

**Figure 6:** Theoretical and predicted amplitude wave of the soliton propagating over a discontinued bed. The point  $x = 0$  coincides with the discontinuous bottom point.

where  $\lambda$  is the initial amplitude,  $x$  is the distance traveled by the soliton wave, and  $\nu$  is the kinematic viscosity of the fluid. In [40], numerical results solving the Navier-Stokes equation match with the above theoretical result. The formula (7.1) to prove that the soliton generalized solution approximates the theoretical result is used in this paper.

We take the example described in [40] which considered the discontinuity bottom as  $h_1 = 80$  cm,  $h_2 = 40$  cm, and the initial amplitude  $\lambda = 4$  cm. The theoretical result for this case using the formula (7.1) is compared with numerical solution of the system of (5.15)–(5.18). To approximate the theoretical solution, we present the generalized solution assuming that the constant  $M$  in system of (6.1)–(6.2) depends on  $x/h_2$ , that is,  $M = M(x/h_2)$ . This assumption enables us to show that the solution of (5.15)–(5.18) can reproduce well several amplitude step soliton values above the break point. We seek the values of the  $M(x/h_2)$  that better adjusted the theoretical amplitude in (7.1) (see Figure 6). To do so, we use the solver *fmincon.m* in MATLAB 7.0. In Figure 6 is shows the theoretical and predicted step soliton amplitude when pass on a discontinuous depth point ( $x = 0$ ).

In [46] was performed experiments to investigate the harmonic generation as periodic waves propagate over a submerged porous breakwater. Their experimental data will be used to test the validation of the present model equations for the wave and discontinuous bottom point interaction. We check that the generalized solution can reproduce well this experimental values.

Although we have been adjusted the method well to both theoretic and experimental data, this result constitutes a first approximation of application of Colombeau's algebra, because we consider as a constant in time and space the amplitude of step soliton generalized function. Also, we do not consider here the friction effect and the time dependency amplitude wave. An other facility is that the parameter  $M$  that appears in (5.15) can be estimated from several experimental runs looking for any regularity.

## 8. Conclusion

In this paper generalized solutions in the sense of Colombeau of Shallow water equations are obtained. This solution is consistent with numerical and theoretical results of a soliton passing over a flat or discontinuity bottom geometries. The method developed in this paper

reduces the partial differential equation to determine the zeros of a functional equation. This procedure also will allow us to study a propagation of several types of singularities on several bottom geometries.

## Acknowledgments

The authors are grateful to Herminia Serrano Mendez for their collaboration. They thank the oceanographer Alina Rita Gutierrez Delgado for helpful discussions and review of the paper. They are also very pleased of the reviewers who helped them improve the paper. The authors appreciate the help of Dan Marchesin and special thanks for Iucinara Braga. They also thank IMPA, Brazil and the University of Université des Antilles et de la Guyane.

## References

- [1] R. F. Dressler, "New nonlinear shallow-flow equations with curvature," *Journal of Hydraulic Research*, vol. 16, no. 3, pp. 205–222, 1978.
- [2] C. E. Synolakis, "The runup of solitary waves," *Journal of Fluid Mechanics*, vol. 185, pp. 523–545, 1987.
- [3] J. G. Zhou, D. M. Causon, D. M. Ingram, and C. G. Mingham, "Numerical solutions of the shallow water equations with discontinuous bed topography," *International Journal for Numerical Methods in Fluids*, vol. 38, no. 8, pp. 769–788, 2002.
- [4] J. B. Keller, "Shallow-water theory for arbitrary slopes of the bottom," *Journal of Fluid Mechanics*, vol. 489, pp. 345–348, 2003.
- [5] I. J. Losada, M. D. Patterson, and M. A. Losada, "Harmonic generation past a submerged porous step," *Coastal Engineering*, vol. 31, no. 1–4, pp. 281–304, 1997.
- [6] G. B. Whitham, *Linear and Nonlinear Waves*, Wiley-Interscience, New York, NY, USA, 1974.
- [7] A. A. Petrov, "Variational statement of the problem of liquid motion in a container of finite dimensions," *Journal of Applied Mathematics and Mechanics*, vol. 28, no. 4, pp. 917–922, 1964.
- [8] O. Nwogu, "Alternative form of Boussinesq equations for nearshore wave propagation," *Journal of Waterway, Port, Coastal & Ocean Engineering*, vol. 119, no. 6, pp. 618–638, 1993.
- [9] V. P. Maslov and G. A. Omelyanov, "Asymptotic soliton-like solutions of equations with small dispersion," *Russian Mathematical Surveys*, vol. 36, no. 3, article 73, 1981.
- [10] G. Elchahal, R. Younes, and P. Lafon, "The effects of reflection coefficient of the harbour sidewall on the performance of floating breakwaters," *Ocean Engineering*, vol. 35, no. 11–12, pp. 1102–1112, 2008.
- [11] F. Serre, "Contribution à l'étude des écoulements permanents et variables dans les canaux houille blanche," *Houille Blanche*, no. 8, pp. 374–388, 1953.
- [12] A. Gsponer, "A concise introduction to Colombeau generalized functions and their applications in classical electrodynamics," *European Journal of Physics*, vol. 30, no. 1, pp. 109–126, 2009.
- [13] J. Miles and R. Salmon, "Weakly dispersive nonlinear gravity waves," *Journal of Fluid Mechanics*, vol. 157, pp. 519–531, 1985.
- [14] S. B. Savage and K. Hutter, "The motion of a finite mass of granular material down a rough incline," *Journal of Fluid Mechanics*, vol. 199, pp. 177–215, 1989.
- [15] D. Dutykh and D. Clamond, "Shallow water equations for large bathymetry variations," *Journal of Physics. A*, no. 44, pp. 341–348, 2011.
- [16] F. Bouchut, A. Mangeney-Castelnau, B. Perthame, and J.-P. Vilotte, "A new model of Saint Venant and Savage-Hutter type for gravity driven shallow water flows," *Comptes Rendus Mathématique. Académie des Sciences. Paris*, vol. 336, no. 6, pp. 531–536, 2003.
- [17] J. F. Colombeau, *New Generalized Functions and Multiplication of Distributions*, vol. 84 of *North-Holland Mathematics Studies*, North-Holland, Amsterdam, The Netherlands, 1984.
- [18] G. H. Keulegan, "Gradual damping of solitary waves," *Journal of research of the National Bureau of Standards*, no. 40, pp. 487–498, 1948.
- [19] M. Calabrese, D. Vicinanza, and M. Buccino, "2D Wave setup behind submerged breakwaters," *Ocean Engineering*, vol. 35, no. 10, pp. 1015–1028, 2008.
- [20] A. Nachbin, "A terrain-following Boussinesq system," *SIAM Journal on Applied Mathematics*, vol. 63, no. 3, pp. 905–922, 2003.



- [21] A. E. Green and P. M. Naghdi, "Derivation of equations for wave propagation in water of variable depth," *Journal of Fluid Mechanics*, vol. 78, no. 2, pp. 237–246, 1976.
- [22] D. Dutykh and F. Dias, "Dissipative Boussinesq equations," *Comptes Rendus. Mecanique*, vol. 335, no. 9-10, pp. 559–583, 2007.
- [23] R. Bernetti, V. A. Titarev, and E. F. Toro, "Exact solution of the Riemann problem for the shallow water equations with discontinuous bottom geometry," *Journal of Computational Physics*, vol. 227, no. 6, pp. 3212–3243, 2008.
- [24] H. A. Biagioni and M. Oberguggenberger, "Generalized solutions to the Korteweg-de Vries and the regularized long-wave equations," *SIAM Journal on Mathematical Analysis*, vol. 23, no. 4, pp. 923–940, 1992.
- [25] C. C. Mei, *The Applied Dynamics of Ocean Surface Waves*, Wiley, New York, NY, USA, 1983.
- [26] J. F. Colombeau, *Elementary Introduction to New Generalized Functions*, vol. 113 of *North-Holland Mathematics Studies*, North-Holland, Amsterdam, The Netherlands, 1985.
- [27] J. F. Colombeau, "Generalized functions and infinitesimals," Tech. Rep., 2006, <http://arxiv.org/abs/math/0610264>.
- [28] S. Hamdi, W. H. Enright, Y. Ouellet, and W. E. Schiesser, "Method of lines solutions of the extended Boussinesq equations," *Journal of Computational and Applied Mathematics*, vol. 183, no. 2, pp. 327–342, 2005.
- [29] C.-J. Huang and C.-M. Dong, "On the interaction of a solitary wave and a submerged dike," *Coastal Engineering*, vol. 43, no. 3-4, pp. 265–286, 2001.
- [30] J. McCowan, "On the solitary wave," *London, Edinburgh and Dublin Philosophical Magazine and Journal of Science*, vol. 5, no. 12, pp. 45–58, 1891.
- [31] V. P. Maslov and G. A. Omelyanov, "Conditions of Hugoniot type for infinitely narrow solutions of the simple wave equation," *Sibirskii Matematicheskii Zhurnal*, vol. 24, no. 5, pp. 787–795, 1983.
- [32] V. P. Maslov and V. A. Cupin, "Necessary conditions for the existence of infinitely narrow solitons in gas dynamics," *Soviet Physics, Doklady*, vol. 246, no. 2, pp. 298–300, 1979.
- [33] M. Nedeljkov, "Infinitely narrow soliton solutions to systems of conservation laws," *Novi Sad Journal of Mathematics*, vol. 31, no. 2, pp. 59–68, 2001.
- [34] C. O. R. Sarrico, "New solutions for the one-dimensional nonconservative inviscid Burgers equation," *Journal of Mathematical Analysis and Applications*, vol. 317, no. 2, pp. 496–509, 2006.
- [35] C. O. R. Sarrico, "Entire functions of certain singular distributions and interaction of delta-waves in nonlinear conservation laws," *International Journal of Mathematical Analysis*, vol. 4, no. 33-36, pp. 1765–1778, 2010.
- [36] F. Bouchut, A. Mangeney-Castelnaud, B. Perthame, and J.-P. Vilotte, "A new model of Saint Venant and Savage-Hutter type for gravity driven shallow water flows," *Comptes Rendus Mathématique. Académie des Sciences. Paris*, vol. 336, no. 6, pp. 531–536, 2003.
- [37] R. Bernetti, V. A. Titarev, and E. F. Toro, "Exact solution of the Riemann problem for the shallow water equations with discontinuous bottom geometry," *Journal of Computational Physics*, vol. 227, no. 6, pp. 3212–3243, 2008.
- [38] F. Chazel, "Influence of bottom topography on long water waves," *M2AN. Mathematical Modelling and Numerical Analysis*, vol. 41, no. 4, pp. 771–799, 2007.
- [39] Z. Zhong and K. H. Wang, "Solitary wave interaction with a concentric porous cylinder system," *Ocean Engineering*, vol. 33, no. 7, pp. 927–949, 2006.
- [40] K. V. Karelsky, V. V. Papkov, A. S. Petrosyan, and D. V. Tsygankov, "Particular solutions of shallow-water equations over a non-flat surface," *Physics Letters. A*, vol. 271, no. 5-6, pp. 341–348, 2000.
- [41] C. Lin, T. C. Ho, S. C. Chang, S. C. Hsieh, and K. A. Chang, "Vortex shedding induced by a solitary wave propagating over a submerged vertical plate," *International Journal of Heat and Fluid Flow*, vol. 26, no. 6, pp. 894–904, 2005.
- [42] P. A. Madsen, H. B. Bingham, and H. A. Schäffer, "Boussinesq-type formulations for fully nonlinear and extremely dispersive water waves: derivation and analysis," *The Royal Society of London. Proceedings. Series A. Mathematical, Physical and Engineering Sciences*, vol. 459, no. 2033, pp. 1075–1104, 2003.
- [43] J. B. Christopher and R. D. Dean, "Wave transformation by two-dimensional bathymetric anomalies with sloped transitions," *Coastal Engineering*, vol. 50, no. 1-2, pp. 61–84, 2003.
- [44] J. Fenton, "A ninth-order solution for the solitary wave," *The Journal of Fluid Mechanics*, vol. 58, no. 2, pp. 257–271, 1972.
- [45] C. C. Mei, "Resonant reflection of surface water waves by periodic sandbars," *Journal of Fluid Mechanics*, vol. 152, pp. 315–335, 1985.

- [46] M. A. Losada, A. C. Vidal, and R. Medina, "Experimental study of the evolution of a solitary wave at an abrupt junction," *Journal of Geophysical Research*, no. 94, pp. 557–566, 1989.
- [47] J. F. Colombeau, "Generalized functions and nonsmooth nonlinear problems in mathematics and physics," Tech. Rep., 2006, <http://arxiv.org/abs/math-ph/0612077>.
- [48] A. J. C. de Saint-Venant, "Thorie du mouvement non-permanent des eaux, avec application aux crues des rivières et à l'introduction des mares dans leur lit," *Comptes Rendus de l'Académie des Sciences, Paris*, vol. 73, pp. 147–154, 1871.
- [49] J. F. Colombeau, *Multiplication of Distributions*, vol. 1532 of *Lecture Notes in Mathematics*, Springer, Berlin, Germany, 1992.
- [50] J. F. Colombeau and A. Y. LeRoux, "Multiplications of distributions in elasticity and hydrodynamics," *Journal of Mathematical Physics*, vol. 29, no. 2, pp. 315–319, 1988.
- [51] C.-J. Huang, M. L. Shen, and H. H. Chang, "Propagation of a solitary wave over rigid porous beds," *Ocean Engineering*, vol. 35, no. 11-12, pp. 1194–1202, 2008.
- [52] J. Sander and K. Hutter, "On the development of the theory of the solitary wave. A historical essay," *Acta Mechanica*, vol. 86, no. 1-4, pp. 111–152, 1991.
- [53] J. S. Russell, "On waves," Report of the 14th Meeting of the British Association for the Advancement of Science, 1845.
- [54] H. Lamb, *Hydrodynamics*, Dover, 1945.
- [55] J. Garnier, J. C. Muñoz Grajales, and A. Nachbin, "Effective behavior of solitary waves over random topography," *Multiscale Modeling & Simulation*, vol. 6, no. 3, pp. 995–1025, 2007.
- [56] G. G. Stokes, "The outskirts of the solitary wave," *Mathematical and Physical Papers*, no. 5, p. 63, 1905.
- [57] S.-J. Liang, J.-H. Tang, and M.-S. Wu, "Solution of shallow-water equations using least-squares finite-element method," *Acta Mechanica Sinica*, vol. 24, no. 5, pp. 523–532, 2008.
- [58] E. V. Laitone, "The second approximation to cnoidal and solitary waves," *Journal of Fluid Mechanics*, vol. 9, pp. 430–444, 1960.

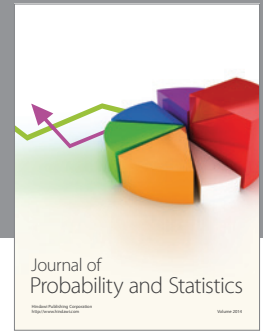
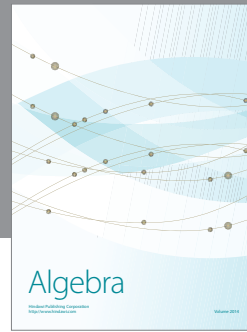

# Hindawi

Submit your manuscripts at  
<http://www.hindawi.com>

