

## ABOUT SOME INFINITE FAMILY OF 2-BRIDGE KNOTS AND 3-MANIFOLDS

YANGKOK KIM

(Received 1 December 1998 and in revised form 12 March 1999)

**ABSTRACT.** We construct an infinite family of 3-manifolds and show that these manifolds have cyclically presented fundamental groups and are cyclic branched coverings of the 3-sphere branched over the 2-bridge knots  $(\ell + 1)_2$  or  $(\ell + 1)_1$ , that are the closure of the rational  $(2\ell - 1)/(\ell - 1)$ -tangles or  $(2\ell - 1)/\ell$ -tangles, respectively.

**Keywords and phrases.** 2-bridge knot, 3-manifold, branched covering, maximally symmetric.

2000 Mathematics Subject Classification. Primary 57M12, 57M50; Secondary 57M25.

**1. Introduction.** The purpose of this paper is to investigate the connection between cyclically presented groups and cyclic branched coverings of  $\mathbb{S}^3$  branched over knots or links. This kind of works can be found in many papers (cf. [2, 4, 7, 8, 9, 12, 13]).

Let  $F_n = \langle x_1, \dots, x_n \mid \ \ \rangle$  be the free group of rank  $n$  and  $\eta : F_n \rightarrow F_n$  be the automorphism of order  $n$  such that  $\eta(x_i) = x_{i+1}$ ,  $i = 1, \dots, n$ , where the indices are taken mod  $n$ . Then for a reduced word  $w \in F_n$ , the *cyclically presented group*  $G_n(w)$  is given by

$$G_n(w) = \langle x_1, \dots, x_n \mid w, \eta(w), \dots, \eta^{n-1}(w) \rangle. \quad (1.1)$$

A group  $G$  is said to have a *cyclic presentation* if  $G$  is isomorphic to  $G_n(w)$  for some  $n$  and  $w$ .

Let  $\mathcal{K}$  be a knot in the 3-sphere  $\mathbb{S}^3$ . We will say that a 3-dimensional manifold  $M$  is an  $n$ -fold cyclic branched covering of the knot  $\mathcal{K}$  if  $M$  is an  $n$ -fold cyclic branched covering of  $\mathbb{S}^3$  branched over the knot  $\mathcal{K}$  (see [1, 14]). In other words,  $M$  is the covering of the orbifold  $\mathcal{K}(n)$  with underlying space  $\mathbb{S}^3$  and the singular set the knot  $\mathcal{K}$ . In this case, the fundamental group of the manifold has a cyclic automorphism and the split extension is the group of the orbifold  $\mathcal{K}(n)$ . So it is interesting to find a cyclic presentation for the fundamental group of the manifold, corresponding to this cyclic covering.

For  $\mathcal{K} = 4_1$ , the figure-eight knot, it was shown in [8] that there is a closed orientable 3-manifold  $M_n$ , called the *Fibonacci manifold*, such that:

(i) The fundamental group  $\pi_1(M_n) = F(2, 2n)$ , where

$$F(2, 2n) = \langle a_1, \dots, a_{2n} \mid a_i a_{i+1} = a_{i+2}, i \bmod 2n \rangle. \quad (1.2)$$

(ii)  $M_n$  is hyperbolic for  $n > 3$  and Euclidean for  $n = 3$ .

The connection between the manifolds  $M_n$  and knot theory was mentioned in [9]. Actually it was shown that

(iii)  $M_n$  is the  $n$ -fold cyclic branched covering of the knot  $4_1$ .

Hence the works for the Fibonacci manifolds constitute the most beautiful examples of the connection between cyclically presented groups and cyclic branched coverings of knots and links. Actually for the construction of the Fibonacci manifold  $M_n$ , a polyhedron schema was considered, that is, the boundary of 3-ball was tessellated into  $n$  triangles in the northern hemisphere,  $n$ -triangles in the southern hemisphere,  $2n$  triangles in the equatorial zone. Then certain orientations and identifications were considered. In this paper, we will consider more general tessellation, that is, the boundary of 3-ball will be tessellated into  $n$  triangles in the northern hemisphere,  $\ell$ -gons in the southern hemisphere,  $n$  triangles and  $n$   $\ell$ -gons in the equatorial zone ( $\ell \geq 3$ ).

For  $\ell \geq 3$  and  $n \geq 2$ , let  $G(\ell, n)$  be a finitely generated group with the following cyclic presentation:

$$G(\ell, n) = \begin{cases} \langle x_1, \dots, x_n \mid x_i^{-1} (x_{i+1} x_i^{-1})^{\frac{\ell-2}{2}} x_{i+1} (x_{i-1} x_i^{-1})^{\frac{\ell-2}{2}} x_{i-1} = 1 \ i \bmod n \rangle, & \text{if } \ell \text{ is even,} \\ \langle x_1, \dots, x_n \mid x_i (x_{i+1}^{-1} x_i)^{\frac{\ell-1}{2}} (x_{i-1}^{-1} x_i)^{\frac{\ell-1}{2}} = 1 \ i \bmod n \rangle, & \text{if } \ell \text{ is odd.} \end{cases} \quad (1.3)$$

In Section 2, we show that  $G(\ell, n)$  can arise as a fundamental group of a closed orientable 3-manifold. In Section 3, we demonstrate that  $G(\ell, n)$  is closely connected with the 2-bridge knot  $(\ell+1)_2$  or  $(\ell+1)_1$ , that is the closure of the rational  $(2\ell-1)/(\ell-1)$ -tangle or  $(2\ell-1)/\ell$ -tangle, according as  $\ell$  is even or odd, respectively (see [14] for notation). In Section 4, we show that the manifold obtained in Section 2 is also obtained as a 2-fold branched covering over an  $n$ -periodic knot. Finally we will have an infinite family of maximally symmetric manifolds in Section 5.

**REMARK 1.1.** In particular, if  $\ell = 3$ , all our properties are the same as the ones for Fibonacci manifolds in [8, 9].

**REMARK 1.2.** In the case of  $\ell = 4$ , all the above properties were observed in [11].

**2. The manifolds with their fundamental groups  $G(\ell, n)$ .** We construct a 3-manifold by polyhedron description and demonstrate that  $G(\ell, n)$  arises as a fundamental group of a 3-manifold.

**THEOREM 2.1.**  $G(\ell, n)$  is a fundamental group of a 3-dimensional manifold for all  $\ell \geq 3$  and all  $n \geq 2$ .

**PROOF.** We assume that  $\ell$  is odd and consider a tessellation on the boundary of 3-ball, which can be regarded as a polyhedron  $P(\ell, n)$ , consisting of  $n$  triangles  $F_i$  in the northern hemisphere,  $n$   $\ell$ -gons  $T_i$  in the southern hemisphere,  $n$  triangles  $F'_i$  and  $n$   $\ell$ -gons  $T'_i$  in the equatorial zone. Then the polyhedron  $P(\ell, n)$  has  $4n$  faces,  $(3+\ell)n$  edges,  $(\ell-1)n+2$  vertices. The oriented edges can be labeled in the following manner.

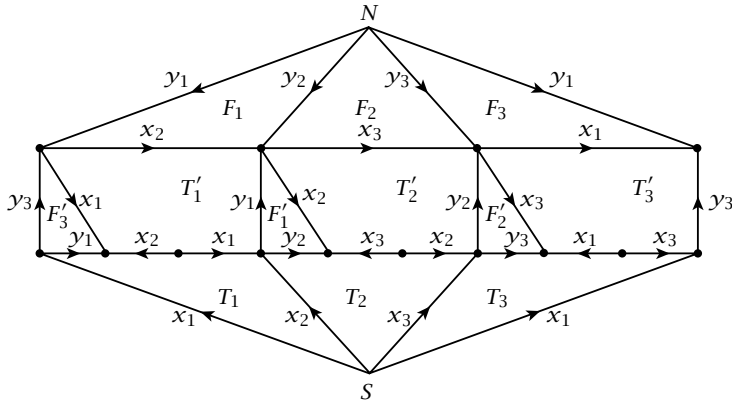

(a) The polyhedron  $P(5,3)$ .

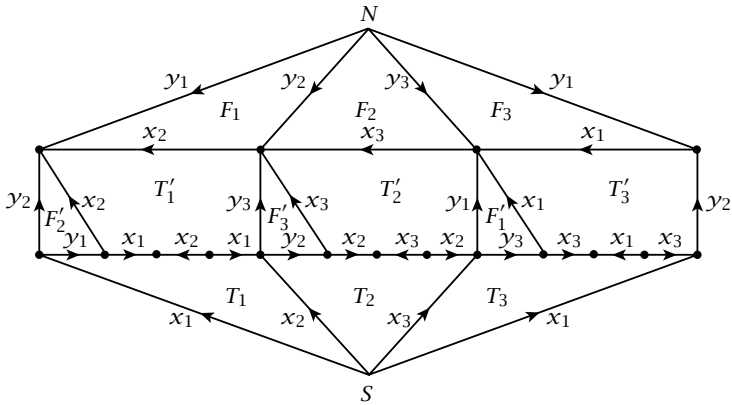

(b) The polyhedron  $P(6,3)$ .

FIGURE 2.1.

(i) The oriented edges fall into  $2n + 1$  classes:  $x_i, i = 1, \dots, n$ , where each class  $x_i$  consists  $\ell$  edges,  $y_i, i = 1, \dots, n$ , where each class  $y_i$  consists 3 edges. In this case, oriented edges from the same class carry the same label.

(ii) For each  $i = 1, \dots, n$ , the boundary cycle of the  $\ell$ -gons  $T_i$  and  $T'_i$  is  $y_{i+2}(x_i x_{i+1}^{-1})^{(\ell-1)/2}$  with the indices taken mod  $n$ .

(iii) For each  $i = 1, \dots, n$ , the boundary cycle of the triangles  $F_i$  and  $F'_i$  is  $y_i x_{i+1} y_{i+1}^{-1}$  with the indices taken mod  $n$ .

Note that the set of all the faces splits into pairs of faces with the same sequences of oriented boundary edges. Now we identify triangles  $F_i$  with  $F'_i$ , and  $\ell$ -gons  $T_i$  and  $T'_i$  such that the corresponding oriented edges on polygons carrying the same label are identified for each  $i = 1, \dots, n$ . For example, if  $\ell = 5$  and  $n = 3$ , we have the polyhedron  $P(5,3)$  as shown in Figure 2.1a.

The resulting complex  $M(\ell, n)$  has one vertex,  $2n$  1-cells,  $2n$  2-cells and one 3-cell. Then we have a closed connected orientable 3-manifold  $M(\ell, n)$  by applying a simple criterion, due to Seifert and Threlfall [15]: *a complex which is formed by identifying the faces of a polyhedron will be a manifold if and only if its Euler characteristic equals zero.*

For the fundamental group of  $M(\ell, n)$  we select  $N$  as an initial point of the closed paths. Then we have the generating path classes of the fundamental group,  $X_i = x_i$  and  $Y_i = y_i$  for  $i = 1, \dots, n$ . By running around the boundaries of the  $2n$  2-cells of  $M(\ell, n)$ , we get the following relators: for  $i = 1, \dots, n$ ,

$$X_i = X_i, \quad Y_i = Y_i, \quad Y_i(X_{i+1}^{-1}X_i)^{(\ell-1)/2} = 1, \quad X_iY_i^{-1}Y_{i-1} = 1. \quad (2.1)$$

Hence the fundamental group of a manifold  $M(\ell, n)$  is

$$\langle X_1, \dots, X_n, Y_1, \dots, Y_n \mid Y_i(X_{i+1}^{-1}X_i)^{(\ell-1)/2} = 1, Y_{i+1}X_iY_i^{-1} = 1, i \bmod n \rangle. \quad (2.2)$$

Therefore it is isomorphic to  $G(\ell+1, n)$ .

Similar arguments can be applied for the case when  $\ell$  is even (see Figure 2.1b for the orientation and labeling of the edges of  $P(6, 3)$ ).  $\square$

### 3. The split extension of the group $G(\ell, n)$

**THEOREM 3.1.** *For  $\ell \geq 3$ ,  $n \geq 2$ , let  $K_\ell$  be the  $n$ -fold cyclic branched covering of the knot  $(\ell+1)_1$  if  $\ell$  is odd and the knot  $(\ell+1)_2$  if  $\ell$  is even. Then  $\pi_1(K_\ell) \cong G(\ell, n)$ .*

**PROOF.** Let  $\ell$  be odd. We consider a presentation for  $G(\ell, n)$ , which can be easily shown using Tietze transformation with  $y_i(x_{i+1}^{-1}x_i)^{(\ell-1)/2} = 1$  for all  $i = 1, \dots, n$ .

$$\langle x_1, \dots, x_n, y_1, \dots, y_n \mid y_i(x_{i+1}^{-1}x_i)^{(\ell-1)/2} = 1, x_i y_i^{-1} y_{i-1} = 1, i \bmod n \rangle. \quad (3.1)$$

Then we see that the group  $G(\ell, n)$  has a cyclic automorphism  $\rho : x_i \rightarrow x_{i+1}$  and  $y_i \rightarrow y_{i+1}$  of order  $n$ . We consider the split extension  $\hat{G}(\ell, n)$  of group  $G(\ell, n)$  by the cyclic group of automorphisms generated by  $\rho$ .

With notation  $x = x_1$  and  $y = y_1$ ,

$$\begin{aligned} \hat{G}(\ell, n) &= \langle \rho, x, y \mid y((\rho(x))^{-1}x)^{(\ell-1)/2} = 1, xy^{-1}\rho^{-1}(y) = 1, \rho^n = 1 \rangle \\ &= \langle \rho, x, y \mid y((\rho(x))^{-1}x)^{(\ell-1)/2} = 1, x^{-1}\rho = y^{-1}\rho y, \rho^n = 1 \rangle. \end{aligned} \quad (3.2)$$

Note that  $\rho$  and  $x^{-1}\rho$  are conjugate. Let  $\mu = x^{-1}\rho$ . Then  $x = \rho\mu^{-1}$  and  $\mu^n = 1$ . So

$$\begin{aligned} \hat{G}(\ell, n) &= \langle \rho, \mu, y \mid \rho y = y\mu, y = (\mu\rho^{-1}\mu^{-1}\rho)^{(\ell-1)/2}, \rho^n = 1, \mu^n = 1 \rangle \\ &= \langle \rho, \mu \mid \rho(\mu\rho^{-1}\mu^{-1}\rho)^{(\ell-1)/2} = (\mu\rho^{-1}\mu^{-1}\rho)^{(\ell-1)/2}\mu, \rho^n = 1, \mu^n = 1 \rangle. \end{aligned} \quad (3.3)$$

We recall that the group

$$\langle \rho, \mu \mid \rho(\mu\rho^{-1}\mu^{-1}\rho)^{(\ell-1)/2} = (\mu\rho^{-1}\mu^{-1}\rho)^{(\ell-1)/2}\mu \rangle \quad (3.4)$$

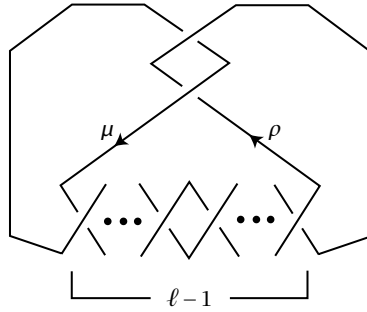

FIGURE 3.1. The knot  $(\ell + 1)_1$ .

is the group of the knot  $(\ell + 1)_1$ , where  $\rho$  and  $\mu$  are shown in Figure 3.1 and the index  $\ell - 1$  in Figure 3.1 denotes the number of half-twists.

Then the group  $\widehat{G}(\ell, n)$  is the fundamental group of the orbifold  $(\ell + 1)_1(n)$ . Hence  $\pi_1(M(\ell, n)) \cong G(\ell, n)$ .

For the case when  $\ell$  is even, we can apply similar arguments. □

**THEOREM 3.2.** *The manifold  $M(\ell, n)$  is the  $n$ -fold cyclic branched covering of the knot  $(\ell + 1)_1$  if  $\ell$  is odd and the knot  $(\ell + 1)_2$  if  $\ell$  is even.*

**PROOF.** Rotation by  $2\pi/n$  about the axis  $NS$  defines an action of  $\mathbb{Z}_n$  on  $M(\ell, n)$ . The quotient of the action is  $\mathbb{S}^3$  and the image of the axis  $NS$  is the knot  $k$ . The isotropy group of a point of  $M(\ell, n)$  not on  $NS$  is trivial. The quotient  $M(\ell, n)/\mathbb{Z}_n$  is obtained by taking a fundamental domain for the action of  $\mathbb{Z}_n$  on  $M(\ell, n)$  and making identifications (see Figure 3.2a). A Heegaard diagram for this quotient space appears in Figure 3.2b. The thick line in Figure 3.2b is the axis  $NS$ .

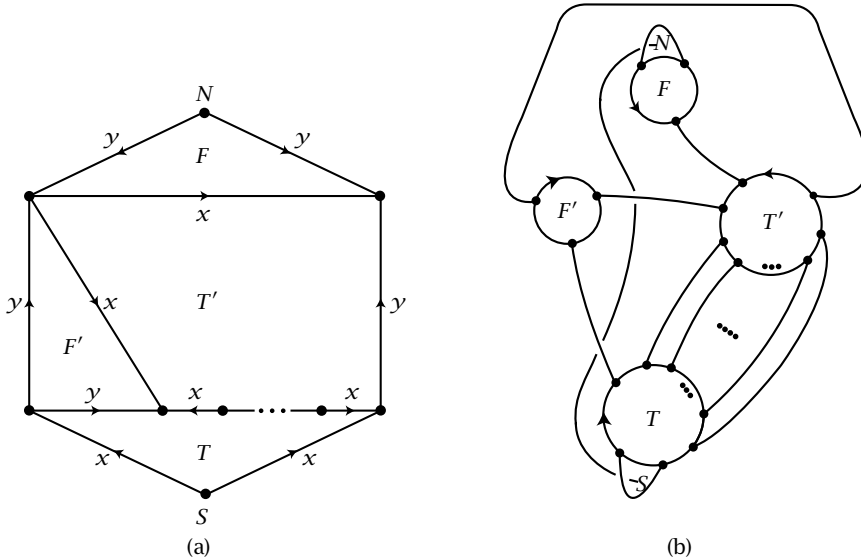

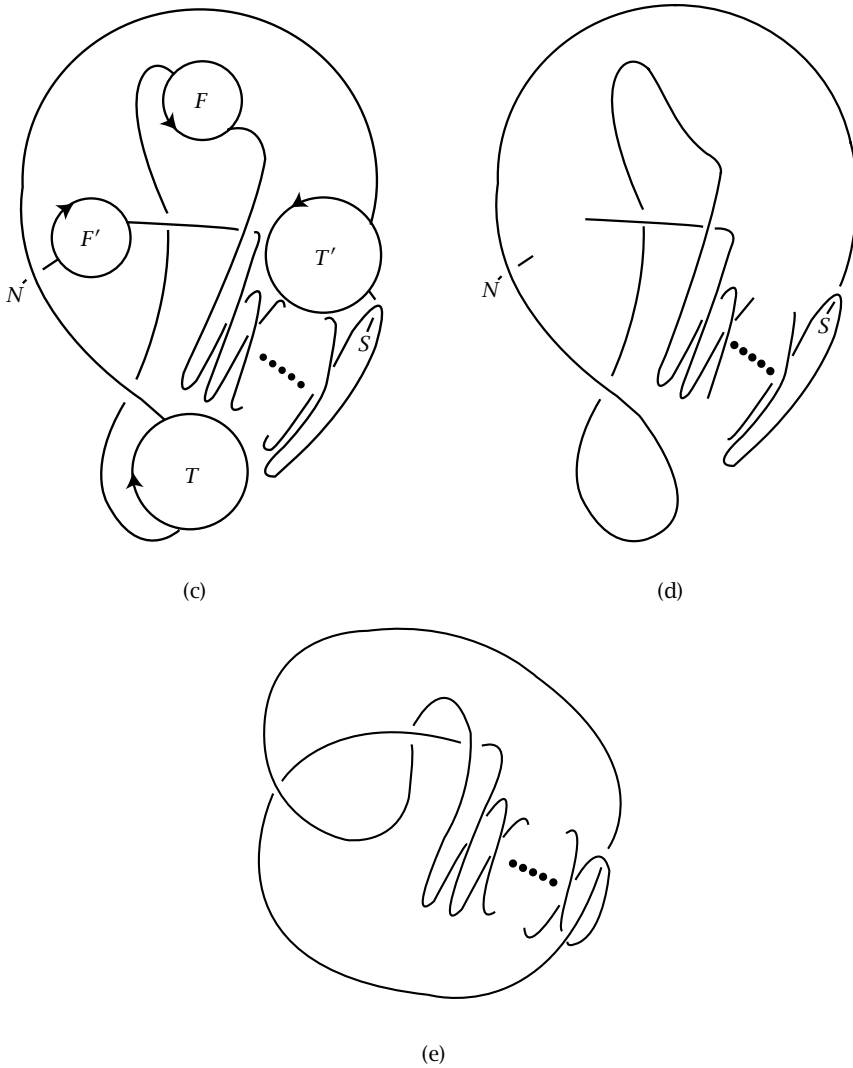

FIGURE 3.2.

It lies below the diagram, inside the ball whose boundary is being identified along the disc pairs  $F, F'$ , and  $T, T'$ . Cancelling handles we obtain  $\mathbb{S}^3$  and the knot  $(\ell + 1)_1$  (see Figures 3.2c, 3.2d, and 3.2e).  $\square$

**THEOREM 3.3** (Thurston). *Assume  $q > 1$ . Then  $(p/q)(n)$  is hyperbolic for*

- (i)  $p = 5, n \geq 4$ ,
- (ii)  $p \neq 5, n \geq 3$ .

*Moreover  $(p/q)(2)$  is spherical for all  $p$ , and  $(5/3)(3)$  is euclidean.*

By Theorem 3.3 (see [5, 10]) we have that the orbifold  $(\ell + 1)_1(n)$  (denoted  $((2\ell - 1)/\ell)(n)$ ) is hyperbolic for  $n \geq 3, \ell \geq 3$ , and it is spherical for  $n = 2, \ell \geq 3$ .

**COROLLARY 3.4.** *The manifold  $M(\ell, n)$  is hyperbolic for all  $n \geq 3$  and all  $\ell \geq 3$ , and  $M(\ell, 2)$  is the lens space  $L(2\ell - 1, \ell - 1)$  for even  $\ell > 3$  or  $L(2\ell - 1, \ell)$  for odd  $\ell \geq 3$ .*

**COROLLARY 3.5.** *The group  $G(\ell, n)$  is infinite for all  $n \geq 3$  and all  $\ell \geq 3$ , and  $G(\ell, 2) \cong \mathbb{Z}_{2\ell-1}$ .*

**4. The manifolds  $M(\ell, n)$  as 2-fold coverings.** In this section, we will study the topological properties of manifolds  $M(\ell, n)$ , that gives a topological approach to the studying of cyclically-presented groups  $G(\ell, n)$ . This study is analogous to the topological studying of Sieradski groups  $S(n)$  and Fibonacci groups  $F(2, 2n)$  given in [2, 3, 9, 16].

Firstly we define a series of knots. We recall that any knot can be obtained as the closure of some braid [1]. Let  $p$  and  $q$  be coprime integers, then by  $\sigma_i^{p/q}$  we denote the rational  $p/q$ -tangle whose incoming arcs are  $i$ th and  $(i + 1)$ th strings. For an integer  $n \geq 1$  we denote by  $\mathcal{K}_n^\ell$  the  $n$ -periodic knot which is the closure of the rational 3-strings braid  $(\sigma_2 \sigma_1^{2/\ell})^n$  or  $(\sigma_2^{-1} \sigma_1^{2/(\ell-1)})^n$  if  $\ell$  is even or odd, respectively. The knot  $\mathcal{K}_4^\ell$  is pictured in Figure 4.1 when  $\ell$  is odd.

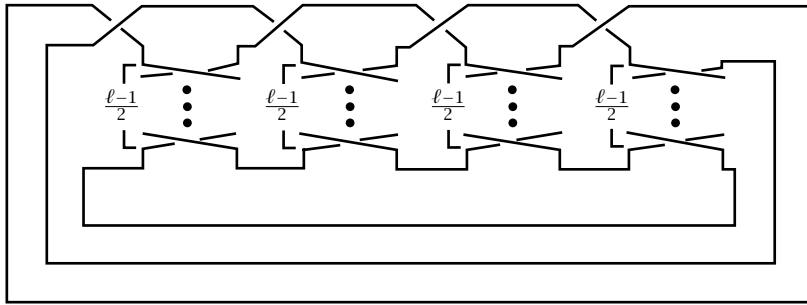

FIGURE 4.1. The knot  $\mathcal{K}_4^\ell$  and  $\ell$  is odd.

**THEOREM 4.1.** *The manifold  $M(\ell, n)$  is the 2-fold covering of the 3-sphere branched over the knot  $\mathcal{K}_n^\ell$  for all  $\ell \geq 3$  and all  $n \geq 2$ .*

**PROOF.** First we assume that  $\ell$  is odd and  $\ell \geq 3$ . By Theorem 3.2 the manifold  $M(\ell, n)$  is the  $n$ -fold cyclic branched covering of the 3-sphere  $\mathbb{S}^3$ , branched over the knot  $(\ell + 1)_1$ . To describe  $M(\ell, n)$  as a 2-fold cyclic branched covering of  $\mathbb{S}^3$ , branched over an  $n$ -periodic knot, we will use the following construction which is analogous to [2, 16] where the Fibonacci groups and the Sieradski groups were topologically studied. From Figure 4.2 we see that the orbifold  $(\ell + 1)_1(n)$  has a rotation symmetry of order two denoted by  $\tau$  such that the axe of the symmetry is disjoint from  $(\ell + 1)_1$ . □

It is not difficult to see that this symmetry action produces an orbifold  $(\ell + 1)_1 / \langle \tau \rangle$  with underlying space  $\mathbb{S}^3$  and the singular set the 2-component link pictured in Figure 4.3 with branch indices 2 and  $n$ . Note that the singular set of the quotient orbifold is

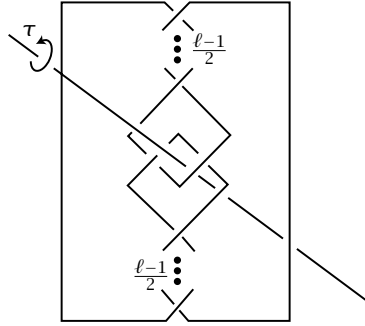

FIGURE 4.2. The knot  $(\ell + 1)_1$  with  $\tau$ .

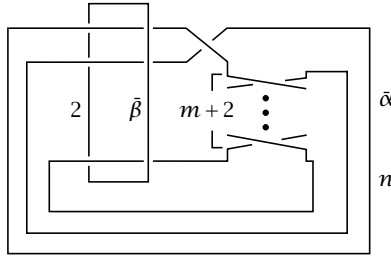

FIGURE 4.3. The singular set of  $(\ell + 1)_1 / \langle \tau \rangle$ .

the two-component link  $b(4\ell - 2, \ell)$ , that is the 2-bridge link obtained as the closure of the rational  $(4\ell - 2)/\ell$ -tangle. We will denote the quotient orbifold  $(\ell + 1)_1 / \langle \tau \rangle$  by  $b(4\ell - 2, \ell)(2, n)$ .

Then we have the following covering diagram:

$$M(\ell, n) \xrightarrow{n} (\ell + 1)_2(n) \xrightarrow{2} b(4\ell - 2, \ell)(2, n) \tag{4.1}$$

and a sequence of normal subgroups

$$G(\ell, n) \triangleleft \hat{G}(\ell, n) \triangleleft \Omega(\ell, n) = \pi_1(b(4\ell - 2, \ell)(2, n)), \tag{4.2}$$

where  $|\Omega(\ell, n) : \hat{G}(\ell, n)| = 2$  and  $|\hat{G}(\ell, n) : G(\ell, n)| = n$ .

We describe the orbifold group  $\Omega(\ell, n)$  using the Wirtinger representation of the link group of  $b(4\ell - 2, \ell)$  in Figure 4.3. The link group has two generators  $\tilde{\alpha}, \tilde{\beta}$  and one relator of the form  $\tilde{\alpha}\tilde{w} = \tilde{w}\tilde{\alpha}$ , where a word  $\tilde{w}$  is determined as follows:

$$w = \tilde{\beta}^{i_1} \tilde{\alpha}^{i_2} \tilde{\beta}^{i_3} \dots \tilde{\alpha}^{i_{(4\ell-4)}} \tilde{\beta}^{i_{(4\ell-3)}}, \tag{4.3}$$

and  $i_j$  is the sign of the number  $\ell j$  by mod  $2(4\ell - 2)$  on the segment  $[-(4\ell - 2), 4\ell - 2]$ . For example, if  $\ell = 5$ , we get a word

$$w = \tilde{\beta} \tilde{\alpha} \tilde{\beta} \tilde{\alpha}^{-1} \tilde{\beta}^{-1} \tilde{\alpha}^{-1} \tilde{\beta}^{-1} \tilde{\alpha} \tilde{\beta} \tilde{\alpha} \tilde{\beta}^{-1} \tilde{\alpha}^{-1} \tilde{\beta}^{-1} \tilde{\alpha}^{-1} \tilde{\beta} \tilde{\alpha} \tilde{\beta}. \tag{4.4}$$



In this representation the generators  $\bar{\alpha}$  and  $\bar{\beta}$  correspond to the arcs with the same labels on the link diagram of  $b(4\ell - 2, \ell)$  in Figure 4.3.

According to [6], we get the following presentation of the orbifold group  $\Omega(\ell, n)$  of the orbifold  $b(4\ell - 2, \ell)(2, n)$ :

$$\Omega(\ell, n) = \langle \alpha, \beta \mid \alpha w = w \alpha, \alpha^n = \beta^2 = 1 \rangle, \tag{4.5}$$

where the generators  $\alpha$  and  $\beta$  canonically correspond to  $\bar{\alpha}$  and  $\bar{\beta}$ , respectively.

Let us consider the group

$$\mathbb{Z}_n \oplus \mathbb{Z}_2 = \langle a \mid a^n = 1 \rangle \oplus \langle b \mid b^2 = 1 \rangle \tag{4.6}$$

and the epimorphism

$$\theta : \Omega(\ell, n) \twoheadrightarrow \mathbb{Z}_n \oplus \mathbb{Z}_2 \tag{4.7}$$

defined by setting  $\theta(\alpha) = a$  and  $\theta(\beta) = b$ . By the construction of the 2-fold covering

$$(\ell + 1)_1(n) \xrightarrow{2} b(4\ell - 2, \ell)(2, n) \tag{4.8}$$

the loop  $\beta \in \Omega(\ell, n)$  lifts to a trivial loop in  $\hat{G}(\ell, n)$ . The loop  $\alpha \in \Omega(\ell, n)$  lifts to a loop in  $\hat{G}(\ell, n)$  which generates a cyclic subgroup of order  $n$ . Thus it follows that

$$\pi_1((\ell + 1)_1(n)) = \theta^{-1}(\langle a \mid a^n = 1 \rangle) = \theta^{-1}(\mathbb{Z}_n). \tag{4.9}$$

For the  $2n$ -fold covering

$$M(\ell, n) \xrightarrow{2n} b(4\ell - 2, \ell)(2, n) \tag{4.10}$$

both loops  $\alpha$  and  $\beta$  in  $\Omega(\ell, n)$  lift to trivial loops in  $G(\ell, n) = \pi_1(M(\ell, n))$ , hence  $G(\ell, n) = \ker \theta$ .

Let  $\Gamma_n$  be the subgroup of  $\Omega(\ell, n)$  given by

$$\Gamma_n = \theta^{-1}(\langle b \mid b^2 = 1 \rangle) = \theta^{-1}(\mathbb{Z}_2). \tag{4.11}$$

Then we get a sequence of normal subgroups

$$G(\ell, n) \triangleleft \Gamma_n \triangleleft \Omega(\ell, n), \tag{4.12}$$

where  $|\Omega(\ell, n) : \Gamma_n| = n$  and  $|\Gamma_n : G(\ell, n)| = 2$ . We recall, that the orbifold  $b(4\ell - 2, \ell)(2, n)$  is spherical for  $n = 2$ , and hyperbolic for  $n \geq 3$ . Hence the group  $\Gamma_n$  acts by isometries on the universal covering  $X_n$ , that is the 3-sphere  $S^3$  for  $n = 2$ , and the hyperbolic space  $\mathbb{H}^3$  for  $n \geq 3$ . Thus we get the orbifold  $X_n/\Gamma_n$  and the following covering diagram:

$$M(\ell, n) \xrightarrow{2} X_n/\Gamma_n \xrightarrow{n} b(4\ell - 2, \ell)(2, n). \tag{4.13}$$

In this case, the second covering is cyclic and it is branched over the component with index  $n$  of the singular set of  $b(4\ell - 2, \ell)(2, n)$  in Figure 4.3. But this component is the knot  $\mathcal{K}_1^\ell$  and is trivial. So, underlying space of  $X_n/\Gamma_n$  is the 3-sphere. By the construction of the  $n$ -fold covering

$$X_n/\Gamma_n \xrightarrow{n} b(4\ell - 2, \ell)(2, n) \tag{4.14}$$

the loop  $\alpha \in \Omega(\ell, n)$  lifts to a trivial loop in  $\Gamma_n$ , and the loop  $\beta \in \Omega(\ell, n)$  lifts to a loop in  $\Gamma_n$  which generates a cyclic group of order 2. Because  $b(4\ell - 2, \ell)$  are 2-bridge links whose components are equivalent, we can exchange branch indices of components in Figure 4.3. Therefore, the singular set of  $X_n/\Gamma_n$  is an  $n$ -periodic knot which can be obtained as the closure of the 3-string braid  $(\sigma_2^{-1}\sigma_1^{2/(\ell-1)})^n$ , that is the knot  $\mathcal{H}_n^\ell$ . Because the branch index is equal to 2, we denote  $X_n/\Gamma_n = \mathcal{H}_n^\ell(2)$ .

Comparing (1) and (2), we get that the following covering diagram is commutative:

$$\begin{array}{ccc}
 M(\ell, n) & \xlongequal{\quad\quad\quad} & M(\ell, n) & \tag{4.15} \\
 \downarrow n & & \downarrow 2 & \\
 (\ell + 1)_1(n) & & \mathcal{K}_n^\ell(2) & \\
 \downarrow 2 & & \downarrow n & \\
 b(4\ell - 2, \ell)(2, n) & \xlongequal{\quad\quad\quad} & b(4\ell - 2, \ell)(2, n) &
 \end{array}$$

If  $\ell$  is even, we see that the orbifold  $(\ell + 1)_2(n)$  has a rotation symmetry of order two denoted by  $\tau$  such that the axe of the symmetry is disjoint from the knot  $(\ell + 1)_2$  (see Figure 4.4).

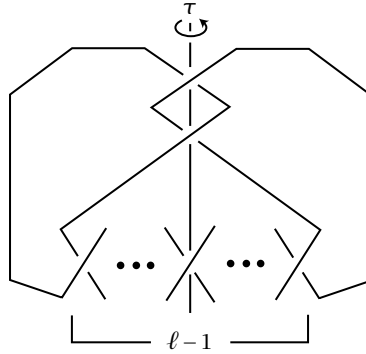

FIGURE 4.4. The knot  $(\ell + 1)_2$ .

Then we can apply the same arguments for odd  $\ell$  to get the following commutative diagram:

$$\begin{array}{ccc}
 M(\ell, n) & \xlongequal{\quad\quad\quad} & M(\ell, n) & \tag{4.16} \\
 \downarrow n & & \downarrow 2 & \\
 (\ell + 1)_2(n) & & \mathcal{H}_n^\ell(2) & \\
 \downarrow 2 & & \downarrow n & \\
 b(4\ell - 2, \ell - 1)(2, n) & \xlongequal{\quad\quad\quad} & b(4\ell - 2, \ell - 1)(2, n) &
 \end{array}$$

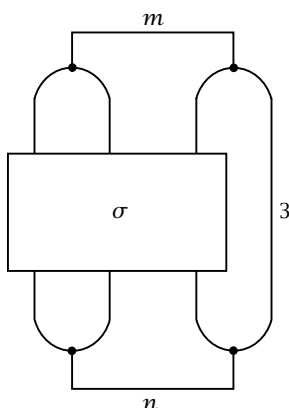

FIGURE 5.1. The singular set of  $\theta(\sigma, m, n)$ .

**5. Maximally symmetric manifolds.** We recall, that the maximal possible order of a finite group  $G$  of orientation-preserving homeomorphisms of the orientable 3-dimensional handlebody  $V_g$  of genus  $g > 1$  is  $12(g - 1)$  [17], analogous to the classical  $84(g - 1)$ -bound for closed Riemann surfaces of genus  $g > 1$ . Let  $M$  be a closed orientable 3-manifold. We will give the following definition according to Zimmermann [18].

**DEFINITION 5.1.** A closed orientable 3-manifold  $M$  is called maximally symmetric if  $M$  has a Heegaard splitting of genus  $g > 1$  and a finite group  $G$  of orientation-preserving homeomorphisms of maximal possible order  $12(g - 1)$  which preserves both handlebodies of the Heegaards splitting (but does not leave invariant a Heegaard splitting of genus zero or 1).

It was shown that some of well-known 3-manifolds are maximally symmetric, for example, the 3-sphere, the projective 3-space, the 3-torus, the Poincaré homology 3-sphere and the Seifert-Weber hyperbolic dodecahedral space. It is also proven that an irreducible maximally symmetric 3-manifold is hyperbolic or Seifert fibred.

Let us consider an orbifold with underlying space  $\mathbb{S}^3$  whose singular set is isomorphic to the spatial graph with four vertices pictured in Figure 5.1, where  $\sigma$  denotes a 3-strings braid and 3,  $m$ ,  $n$  are branch indices of corresponding edges with  $m, n \in \{2, 3, 4, 5\}$  and indices of other edges are equal 2. Following [18], we denote this orbifold by  $\theta(\sigma, m, n)$ .

We will show that the 3-manifold  $M(\ell, 3)$  is also maximally symmetric for all  $\ell \geq 3$  using the following nice criterion from [18].

**THEOREM 5.2** [18]. *The maximally symmetric 3-manifolds  $(M, G)$  are exactly the finite regular coverings of the orbifolds  $\theta(\sigma, m, n)$ .*

Let  $\ell$  be odd. Then the manifold  $M(\ell, 3)$  can be obtained as a 3-fold covering of the 3-sphere branched over the knot  $(\ell + 1)_1$  and the orbifold  $(\ell + 1)_1(3)$  has a rotation symmetry of order two denoted by  $\tau$ .

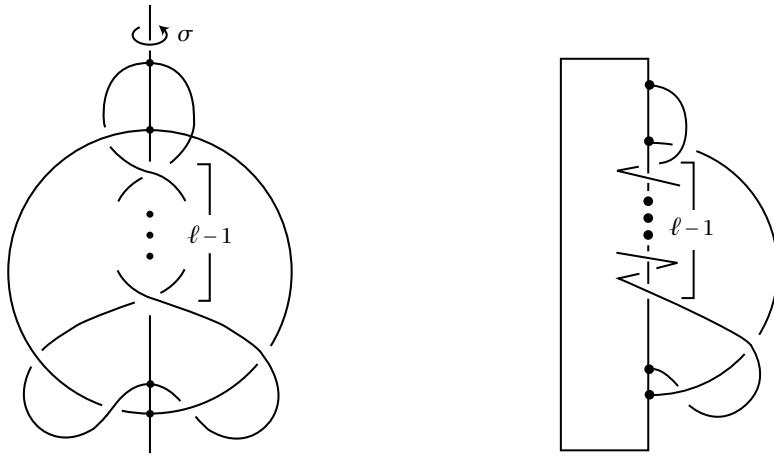

(a) The singular set of  $b(4\ell - 2, \ell)(2, 3)$ .

(b) The singular set of  $b(4\ell - 2, \ell)(2, 3)/\langle \sigma \rangle$ .

FIGURE 5.2.

Thus the quotient space  $b(4\ell - 2, \ell)(2, 3)$  of the orbifold  $(\ell + 1)_1(3)$  by the involution  $\tau$  is an orbifold whose underlying space is the 3-sphere  $S^3$  and whose singular set is two component link  $b(4\ell - 2, \ell)$ . Moreover  $b(4\ell - 2, \ell)(2, 3)$  has an involution  $\sigma$  whose axis intersects the singular set of  $b(4\ell - 2, \ell)(2, 3)$  in four points (see Figure 5.2a). The quotient space  $b(4\ell - 2, \ell)(2, 3)/\langle \sigma \rangle$  by the involution  $\sigma$  is an orbifold whose underlying space is the 3-sphere  $S^3$  and whose singular set is a spatial graph with four vertices, pictured in Figures 5.2 and 5.3, that has one edge with branch index 3 and the other edges with branch indices 2.

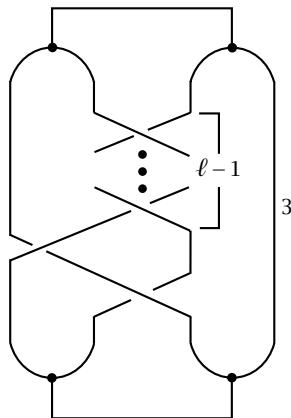

FIGURE 5.3. The singular set of  $b(4\ell - 2, \ell)(2, 3)/\langle \sigma \rangle$ .

Now we see that  $b(4\ell - 2, \ell)(2, 3)/\langle \sigma \rangle$  is the orbifold  $\theta(\sigma_2^{1-\ell}\sigma_1\sigma_2^{-1}, 2, 2)$ . Thus we have the following covering diagram:

$$M(\ell, 3) \xrightarrow{3} (\ell + 1)_1(3) \xrightarrow{2} b(4\ell - 2, \ell)(2, 3) \xrightarrow{2} \theta(\sigma_2^{1-\ell}\sigma_1\sigma_2^{-1}, 2, 2). \quad (5.1)$$

For the case when  $\ell$  is even, we can apply similar arguments.

**LEMMA 5.3.** *The manifold  $M(\ell, 3)$  is a finite regular covering of the orbifold  $\theta(\sigma_2^{1-\ell}\sigma_1\sigma_2^{-1}, 2, 2)$  for all  $\ell \geq 3$ .*

**THEOREM 5.4.** *The manifold  $M(\ell, 3)$  is maximally symmetric for all  $\ell \geq 3$ .*

**ACKNOWLEDGEMENT.** This research was supported by the Research Foundation of Dongeui University in 1998.

#### REFERENCES

- [1] G. Burde and H. Zieschang, *Knots*, de Gruyter Studies in Mathematics, 5, Walter de Gruyter & Co., Berlin, New York, 1985. MR 87b:57004. Zbl 568.57001.
- [2] A. Cavicchioli, F. Hegenbarth, and A. C. Kim, *A geometric study of Sieradski groups*, Algebra Colloq. 5 (1998), no. 2, 203-217. MR 2000b:57003. Zbl 902.57023.
- [3] A. Cavicchioli and F. Spaggiari, *The classification of 3-manifolds with spines related to Fibonacci groups*, Algebraic Topology, Homotopy and Group Cohomology (San Feliu de Guixols, 1990) (Berlin), Lecture Notes in Math., vol. 1509, Springer Verlag, 1992, pp. 50-78. MR 93m:57003. Zbl 752.57007.
- [4] W. D. Dunbar, *Geometric orbifolds*, Rev. Mat. Univ. Complut. Madrid 1 (1988), no. 1-3, 67-99. MR 90k:22011. Zbl 655.57008.
- [5] M. J. Dunwoody, *Cyclic presentations and 3-manifolds*, Groups—Korea '94 (Pusan) (Berlin) (A. C. Kim and D. L. Johnson, eds.), de Gruyter, 1995, Proceedings of the 3rd International Conference on the Theory of Groups held at Pusan National University, Pusan, August 18-25, 1994, pp. 47-55. MR 98h:20067. Zbl 871.20026.
- [6] A. Haefliger and N. D. Quach, *Appendice: une présentation du groupe fondamental d'une orbifold [Appendix: Presentation of the fundamental group of an orbifold]*, Astérisque (1984), no. 116, 98-107. MR 86c:57026b. Zbl 556.57032.
- [7] H. Helling, A. C. Kim, and J. L. Mennicke, *Some honey-combs in hyperbolic 3-space*, Comm. Algebra 23 (1995), no. 14, 5169-5206. MR 97c:51010. Zbl 960.13339.
- [8] ———, *A geometric study of Fibonacci groups*, J. Lie Theory 8 (1998), no. 1, 1-23. MR 99c:57005. Zbl 896.20026.
- [9] H. M. Hilden, M. T. Lozano, and J. M. Montesinos-Amilibia, *The arithmeticity of the figure eight knot orbifolds*, Topology '90 (Columbus, OH, 1990) (Berlin) (B. Apanasov, W. Neumann, A. Ried, and L. Siebenmann, eds.), Ohio State Univ. Math. Res. Publ., vol. 1, de Gruyter, 1992, pp. 169-183. MR 93k:57012. Zbl 767.57004.
- [10] C. Hodgson, *Degeneration and regeneration of geometric structures on three-manifolds*, Ph.D. thesis, Princeton University, 1986.
- [11] G. S. Kim, Y. Kim, and A. Y. Vesnin, *The knot  $5_2$  and cyclically presented groups*, J. Korean Math. Soc. 35 (1998), no. 4, 961-980. MR 99k:57002. Zbl 916.57015.
- [12] C. Maclachlan, *Generalisations of Fibonacci numbers, groups and manifolds*, Combinatorial and Geometric Group Theory (Edinburgh, 1993) (Cambridge) (A. J. Duncan, N. D. Gilbert, and J. Howie, eds.), London Math. Soc. Lecture Note Ser., vol. 204, Cambridge Univ. Press, 1995, pp. 233-238. MR 96e:20044. Zbl 851.20026.
- [13] A. Mednykh and A. Vesnin, *On the Fibonacci groups, the Turk's head links and hyperbolic 3-manifolds*, Groups—Korea '94 (Pusan) (Berlin) (A. C. Kim and D. L. Johnson, eds.), de Gruyter, 1995, Proceedings of the 3rd International Conference on the Theory

- of Groups held at Pusan National University, Pusan, August 18-25, 1994, pp. 231-239. MR 98g:20061. Zbl 871.57001.
- [14] D. Rolfsen, *Knots and Links*, Mathematics Lecture Series, No. 7, Publish or Perish Inc., Berkeley, Calif., 1976. MR 58#24236. Zbl 339.55004.
- [15] H. Seifert and W. Threlfall, *Seifert and Threlfall: A Textbook of Topology*, Academic Press Inc. [Harcourt Brace Jovanovich Publishers], New York, 1980. MR 82b:55001. Zbl 469.55001.
- [16] A. Y. Vesnin and A. D. Mednykh, *Fibonacci manifolds as two-sheeted coverings over a three-dimensional sphere, and the Meyerhoff-Neumann conjecture*, *Sibirsk. Mat. Zh.* **37** (1996), no. 3, 534-542, ii (Russian), translated in *Siberian Math. J.* **37** (1996), no. 3, 461-467. MR 98f:57033. Zbl 882.57011.
- [17] B. Zimmermann, *Über Abbildungsklassen von Henkelkörpern*, *Arch. Math. (Basel)* **33** (1979/80), no. 4, 379-382. MR 82k:57002. Zbl 416.57003.
- [18] ———, *Hurwitz groups and finite group actions on hyperbolic 3-manifolds*, *J. London Math. Soc. (2)* **52** (1995), no. 1, 199-208. MR 96k:57011. Zbl 836.57009.

YANGKOK KIM: DEPARTMENT OF MATHEMATICS, DONGEUI UNIVERSITY, 24, KAYA DONG, PUSANJIN-KU, PUSAN, 614-714, KOREA

*E-mail address:* ykkim@hyomin.dongeu.ac.kr